

1993 NINJA® ZX™-6 PARTS DIAGRAM

Brake Pedal/Torque Link

F2260

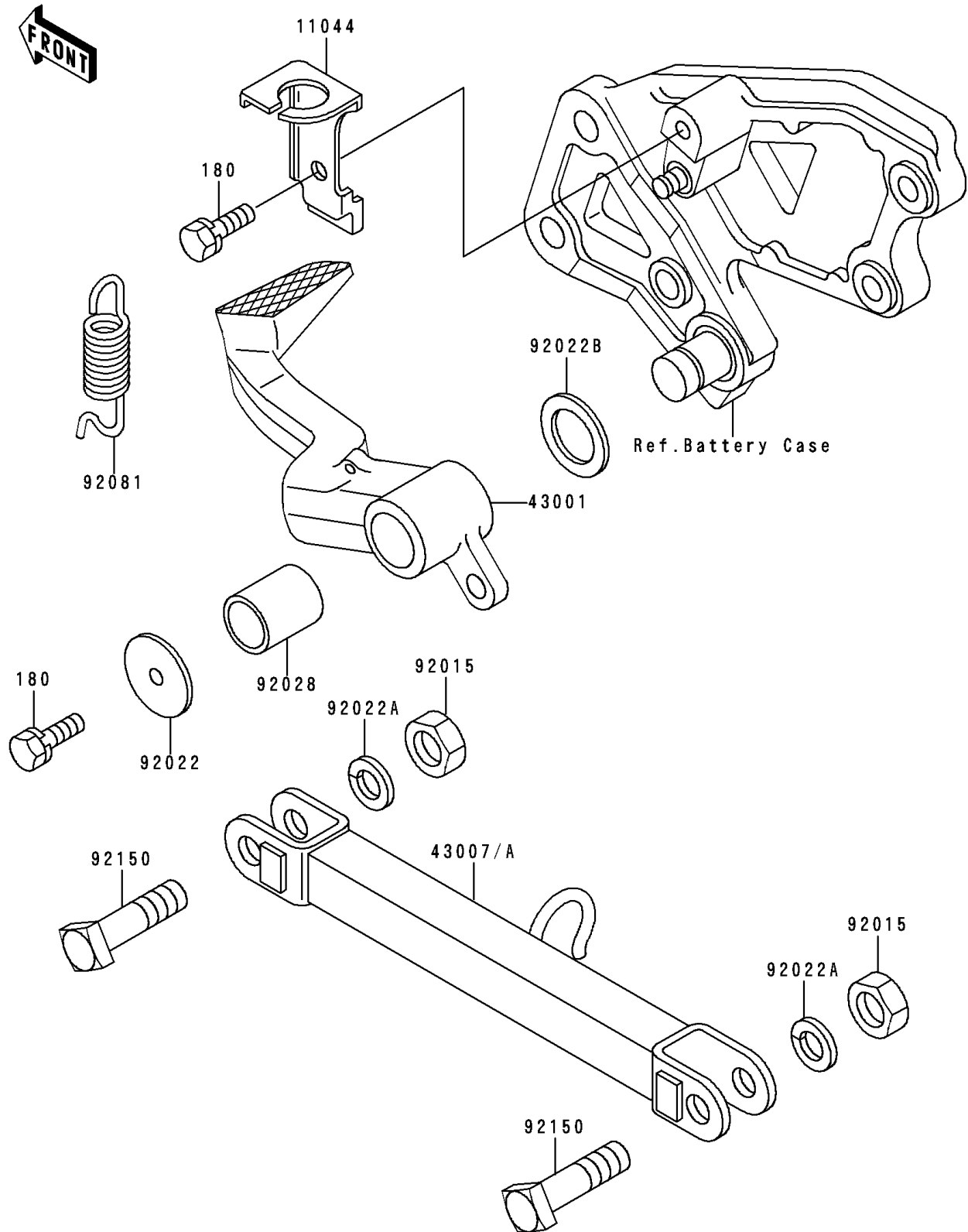

1993 NINJA® ZX™-6 PARTS LIST

Brake Pedal/Torque Link

ITEM NAME	PART NUMBER	QUANTITY
BOLT-UPSET-WS (Ref # 180)	180H0614	1
BRACKET,RR BRAKE SWITCH (Ref # 11044)	11044-1107	1
LEVER-BRAKE,PEDAL (Ref # 43001)	43001-1224	1
NUT,LOCK,10MM (Ref # 92015)	92015-1962	1
WASHER,7X28X1.6 (Ref # 92022)	92022-1282	1
WASHER,SPRING,10MM (Ref # 92022A)	92022-1540	1
WASHER,15.3X24X1 (Ref # 92022B)	92022-326	1
BUSHING,BRAKE PEDAL (Ref # 92028)	92028-1282	1
SPRING,BRAKE PEDAL (Ref # 92081)	92081-1833	1
BOLT,10X37 (Ref # 92150)	92150-1901	1
ROD-TORQUE,SILVER NO.35 (Ref # 43007)	43007-1170-TX	1
ROD-TORQUE,SILVER NO.35 (Ref # 43007A)	43007-1170-VZ	1