

1991 NINJA® ZX™-6 PARTS DIAGRAM

Electrical Equipment

F2760

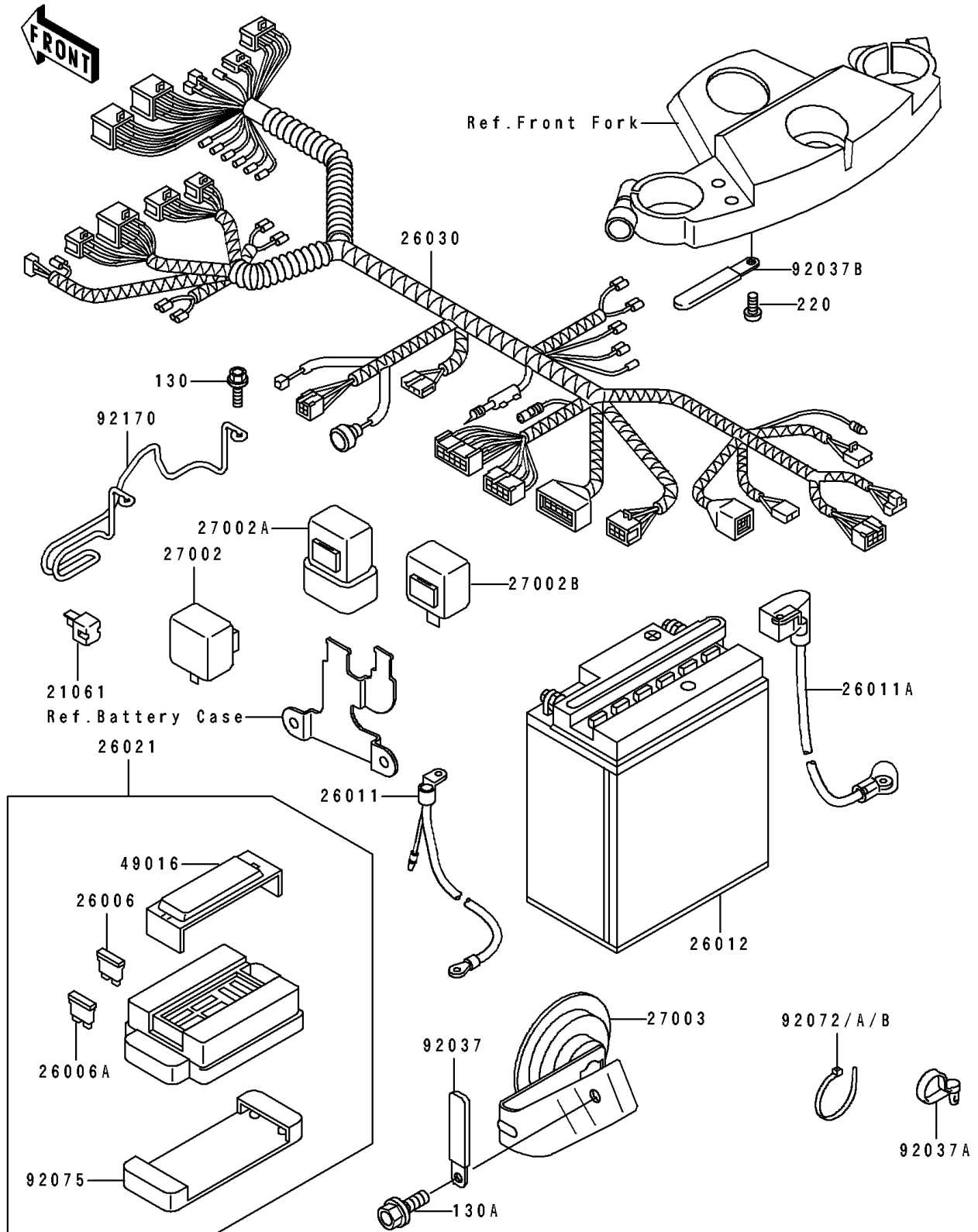

1991 NINJA® ZX™-6 PARTS LIST

Electrical Equipment

ITEM NAME	PART NUMBER	QUANTITY
RECTIFIER (Ref # 21061)	21061-1003	1
FUSE,30A-G (Ref # 26006)	26006-1067	1
FUSE,10A-R (Ref # 26006A)	26006-1068	1
WIRE-LEAD,BATTERY GROUND (Ref # 26011)	26011-1195	1
WIRE-LEAD,BATTERY(+) (Ref # 26011A)	26011-1315	1
BATTERY,FB12A-A,12V 12AH (Ref # 26012)	26012-1246	1
JUNCTION BOX (Ref # 26021)	26021-1077	1
HARNESS,MAIN (Ref # 26030)	26030-1018	1
RELAY-ASSY,TURN SIGNAL (Ref # 27002)	27002-1060	1
RELAY-ASSY,FUEL SENSOR (Ref # 27002A)	27002-1072	1
RELAY-ASSY,FUEL LAMP (Ref # 27002B)	27002-1073	1
HORN,LH (Ref # 27003)	27003-1325	1
COVER-SEAL,FUSE (Ref # 49016)	49016-1125	1
CLAMP (Ref # 92037)	92037-113	1
CLAMP,HOSE (Ref # 92037A)	92037-1163	1
CLAMP,WIRING HARNESS (Ref # 92037B)	92037-1539	1
BAND,L=185 (Ref # 92072)	92072-1195	1
BAND,L=250 (Ref # 92072A)	92072-1237	1
BAND,L=214 (Ref # 92072B)	92072-1276	1
DAMPER,JUNCTION BOX (Ref # 92075)	92075-1688	1
CLAMP (Ref # 92170)	92170-1168	1
BOLT-FLANGED (Ref # 130)	130J0620	1
BOLT-FLANGED,8X20 (Ref # 130A)	130J0820	1
SCREW-PAN-CROS (Ref # 220)	220C0510	1