

1990 NINJA® ZX™-11 PARTS DIAGRAM

Breather Body/Oil Pan

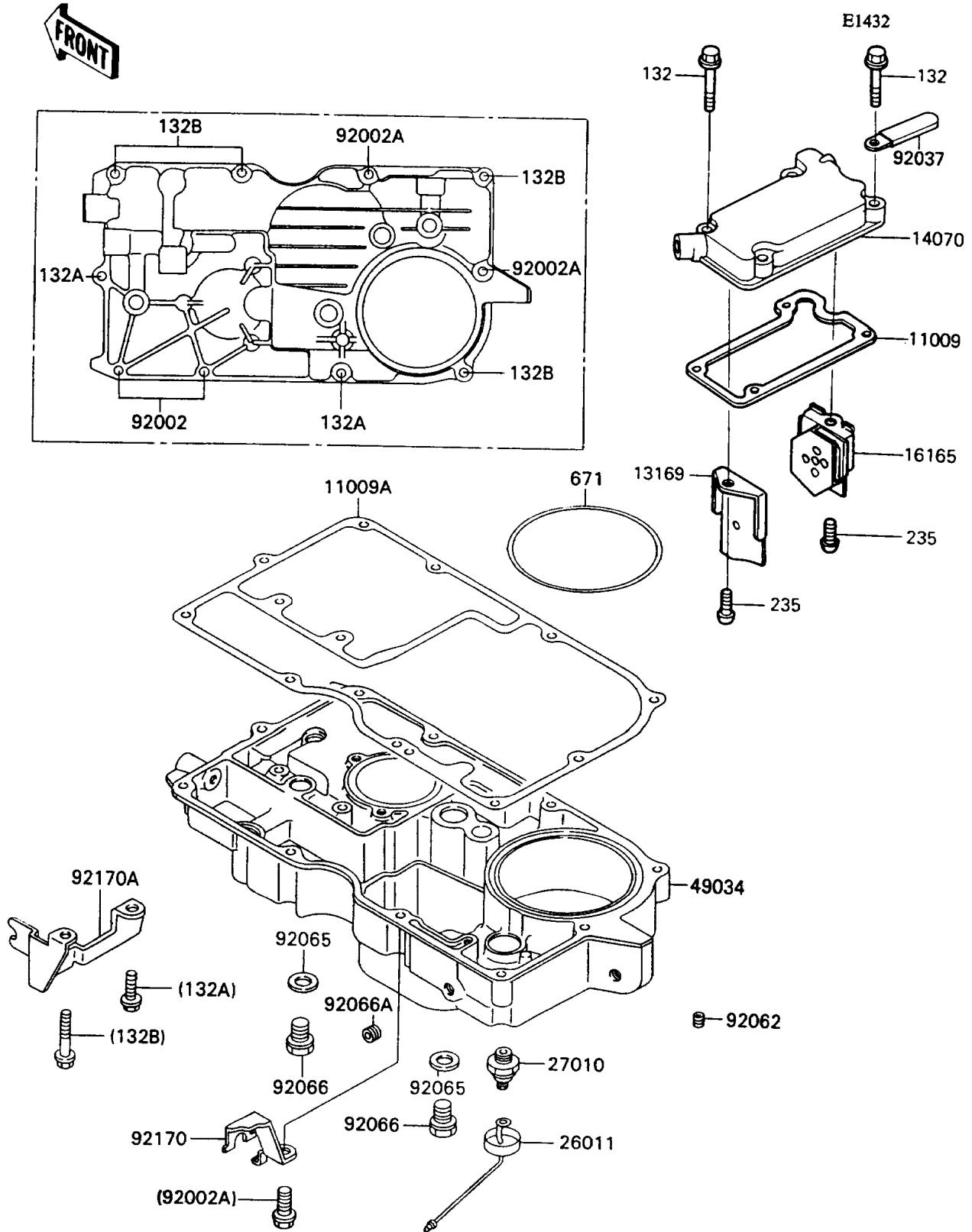

1990 NINJA® ZX™-11 PARTS LIST

Breather Body/Oil Pan

ITEM NAME	PART NUMBER	QUANTITY
GASKET,BREATHER BODY (Ref # 11009)	11009-1861	1
GASKET,OIL PAN (Ref # 11009A)	11009-1981	1
PLATE,BREATHER (Ref # 13169)	13169-1967	1
BODY-BREATHER (Ref # 14070)	14070-1072	1
SEPARATOR,OIL (Ref # 16165)	16165-1053	1
WIRE-LEAD (Ref # 26011)	26011-1371	1
SWITCH,OIL PRESSURE (Ref # 27010)	27010-1155	1
PAN-OIL (Ref # 49034)	49034-1087	1
BOLT,6X25 (Ref # 92002)	92002-1344	1
BOLT,6X40 (Ref # 92002A)	92002-1345	1
CLAMP,WIRING HARNESS (Ref # 92037)	92037-1539	1
NOZZLE,BLACK (Ref # 92062)	92062-011	1
GASKET,12X22X2,DRAIN PLUG (Ref # 92065)	92065-097	1
PLUG,OIL DRAIN,12X15 (Ref # 92066)	92066-1174	1
PLUG,OIL LINE,1/8X7 (Ref # 92066A)	92066-1342	1
CLAMP,OIL TUBE (Ref # 92170)	92170-1188	1
CLAMP,OIL TUBE (Ref # 92170A)	92170-1189	1
BOLT-FLANGED-SMALL (Ref # 132)	132E0625	1
BOLT-FLANGED-SMALL (Ref # 132A)	132J0625	1
BOLT-FLANGED-SMALL,6X40 (Ref # 132B)	132J0640	1
SCREW-PAN-WP-CROS (Ref # 235)	235B0610	1
O RING,90MM (Ref # 671)	671B2590	1