

2009 KX™250F PARTS DIAGRAM

Cables

F2540

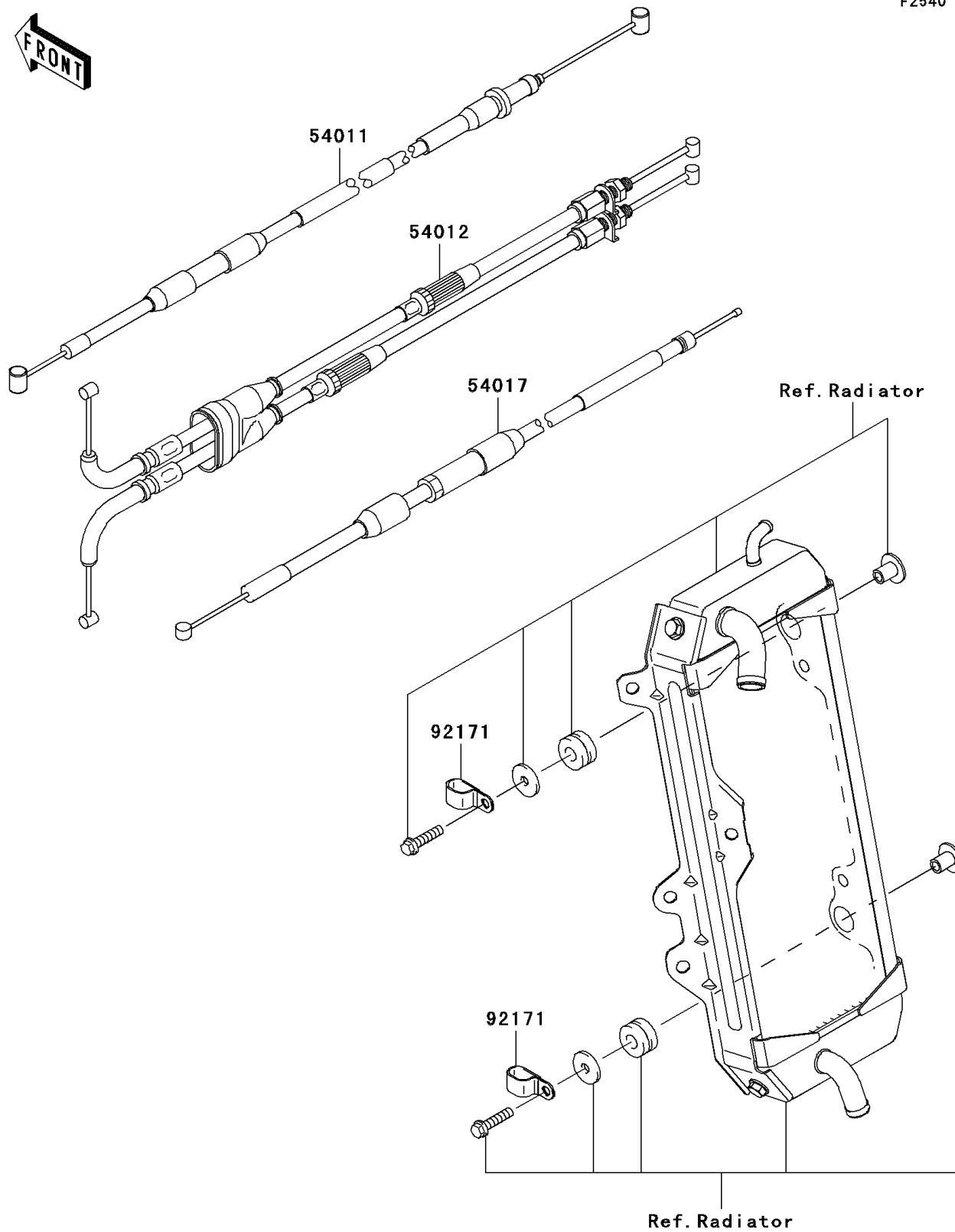

2009 KX™250F PARTS LIST

Cables

ITEM NAME	PART NUMBER	QUANTITY
CABLE-CLUTCH (Ref # 54011)	54011-0087	1
CABLE-THROTTLE (Ref # 54012)	54012-0265	1
CABLE-STARTER (Ref # 54017)	54017-0014	1
CLAMP (Ref # 92171)	92171-0614	1