

2010 KX™85 PARTS DIAGRAM

Front Master Cylinder

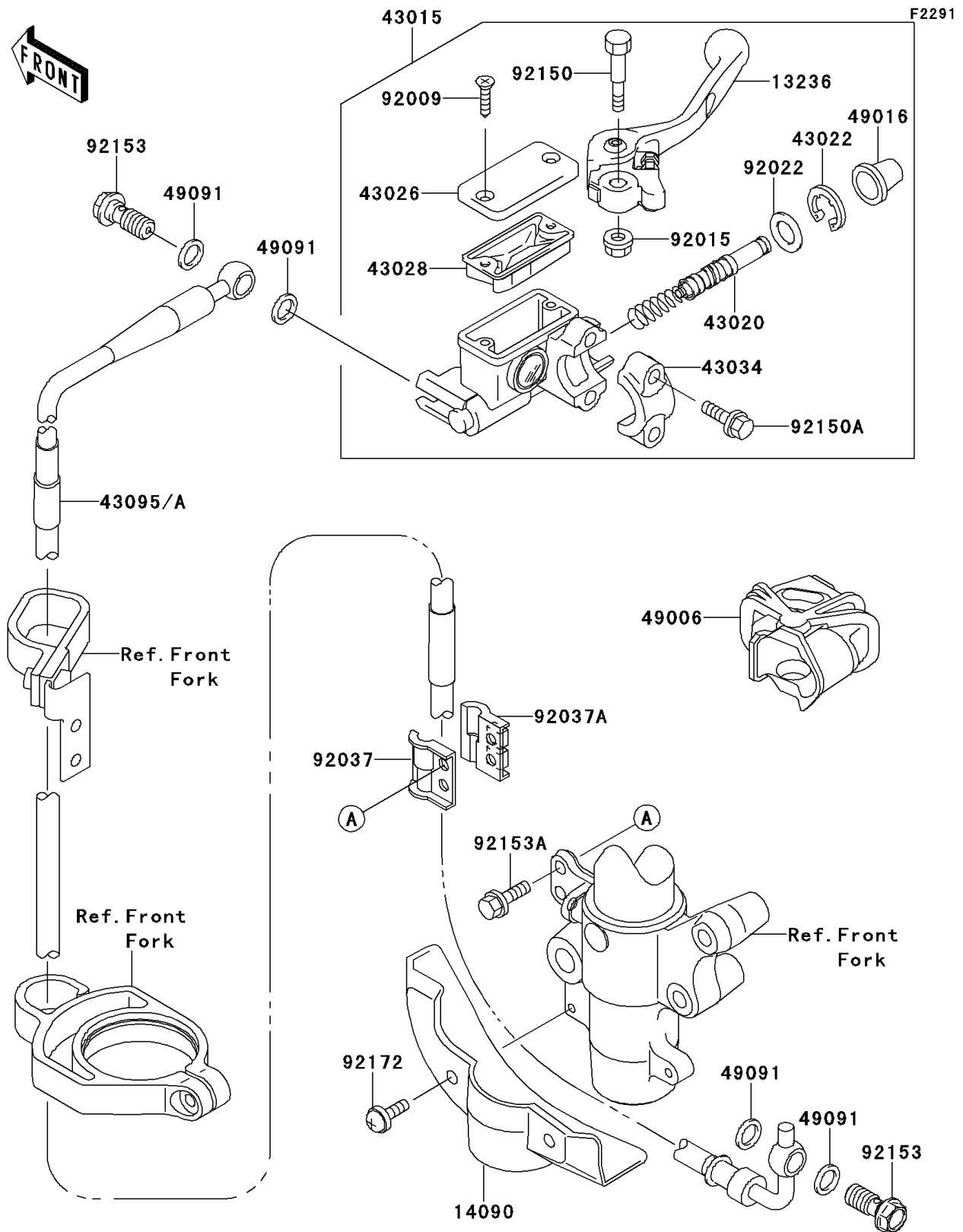

2010 KX™85 PARTS LIST

Front Master Cylinder

ITEM NAME	PART NUMBER	QUANTITY
LEVER-COMP,FRONT BRAKE (Ref # 13236)	13236-1346	1
COVER,BRAKE HOSE,BLACK (Ref # 14090)	14090-1860-6D	1
CYLINDER-ASSY-MASTER,FR (Ref # 43015)	43015-0145	1
PISTON-COMP-BRAKE (Ref # 43020)	43020-1123	1
STOPPER-BRAKE,PISTON (Ref # 43022)	43022-1010	1
CAP-BRAKE,MASTER CYLINDER (Ref # 43026)	43026-0020	1
DIAPHRAGM (Ref # 43028)	43028-1067	1
HOLDER-BRAKE (Ref # 43034)	43034-1110	1
HOSE-BRAKE,FR (Ref # 43095A)	43095-1091	1
BOOT,FRONT BRAKE LEVER (Ref # 49006)	49006-0078	1
COVER-SEAL,MASTER CYLINDER (Ref # 49016)	49016-1044	1
WASHER-SEAL,10.1X14.5X1.5 (Ref # 49091)	49091-0001	1
SCREW,4MM (Ref # 92009)	92009-1458	1
NUT,FLANGED,6MM (Ref # 92015)	92015-1528	1
WASHER (Ref # 92022)	92022-1814	1
CLAMP,BRAKE HOSE,OUTSIDE (Ref # 92037)	92037-1362	1
CLAMP,BRAKE HOSE,INSIDE (Ref # 92037A)	92037-1363	1
BOLT,LEVER SET (Ref # 92150)	92150-1451	1
BOLT (Ref # 92150A)	92150-1452	1
BOLT,OIL,L=23 (Ref # 92153)	92153-0627	1
BOLT,6X16 (Ref # 92153A)	92153-0695	1
SCREW,6X14 (Ref # 92172)	92172-0401	1