

2008 Concours® 14 ABS PARTS DIAGRAM

Gear Change Mechanism

E1370

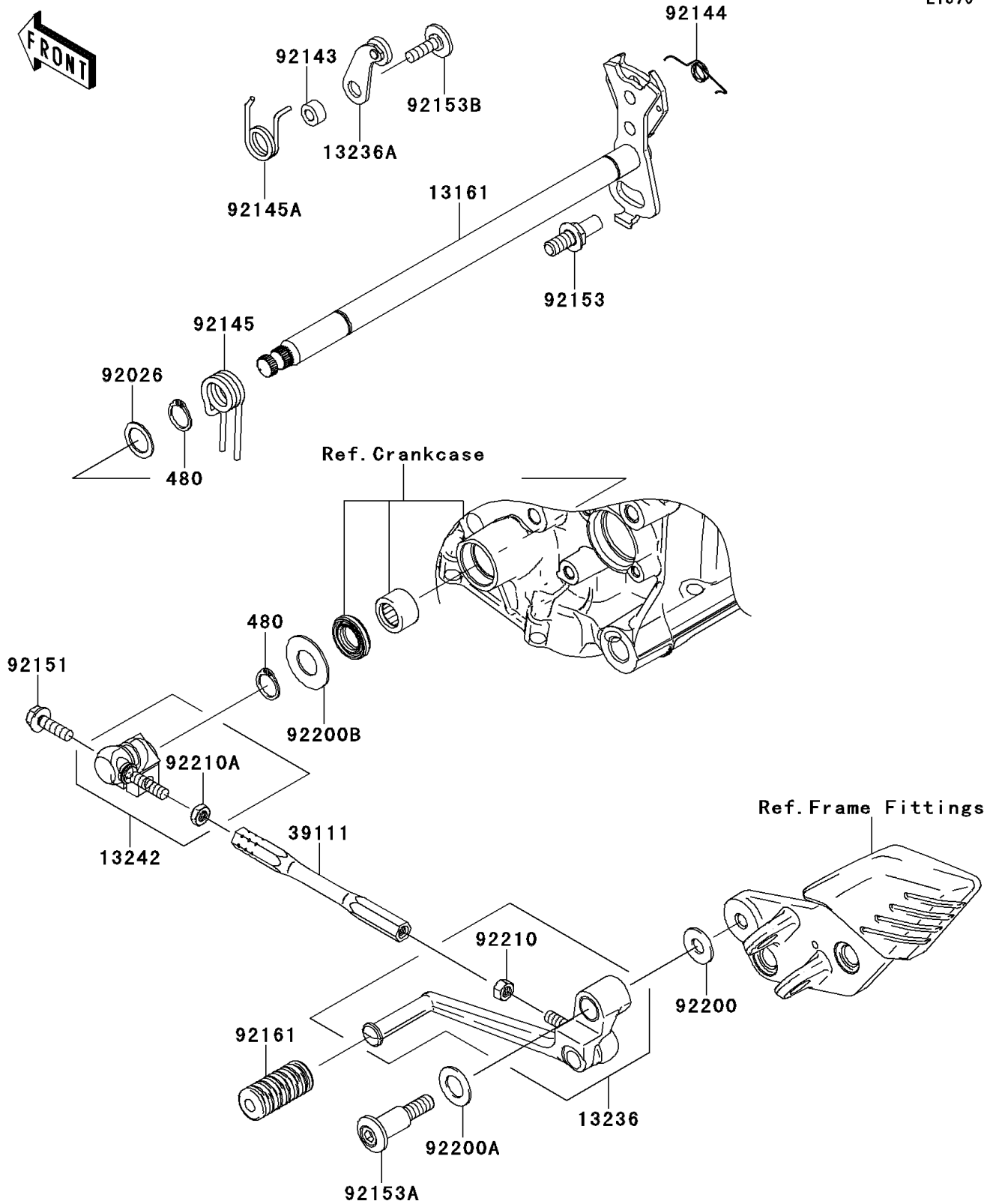

2008 Concours® 14 ABS PARTS LIST

Gear Change Mechanism

ITEM NAME	PART NUMBER	QUANTITY
CIRCLIP-TYPE-C,14MM (Ref # 480)	480J1400	1
LEVER-COMP-CHANGE SHAFT (Ref # 13161)	13161-0034	1
LEVER-COMP,CHANGE PEDAL (Ref # 13236)	13236-0078	1
LEVER-COMP (Ref # 13236A)	13236-1243	1
LEVER-ASSY-CHANGE (Ref # 13242)	13242-0039	1
ROD-TIE (Ref # 39111)	39111-0034	1
SPACER,14X20X1.0 (Ref # 92026)	92026-1534	1
COLLAR (Ref # 92143)	92143-1595	1
SPRING (Ref # 92144)	92144-1029	1
SPRING (Ref # 92145)	92145-0336	1
SPRING (Ref # 92145A)	92145-0404	1
BOLT,FLANGED,6X20 (Ref # 92151)	92151-1226	1
BOLT,RETURN SPRING (Ref # 92153)	92153-0421	1
BOLT,8X41 (Ref # 92153A)	92153-0880	1
BOLT,6X20 (Ref # 92153B)	92153-1505	1
DAMPER,CHANGE PEDAL (Ref # 92161)	92161-1300	1
WASHER,8.5X20X1.5 (Ref # 92200)	92200-0198	1
WASHER,12.5X22X1.2 (Ref # 92200A)	92200-0199	1
WASHER (Ref # 92200B)	92200-0265	1
NUT,6MM (Ref # 92210)	92210-1100	1
NUT,LEFT HANDED,6MM (Ref # 92210A)	92210-1101	1