

2006 Vulcan® 2000 PARTS DIAGRAM

Battery Case

F2132

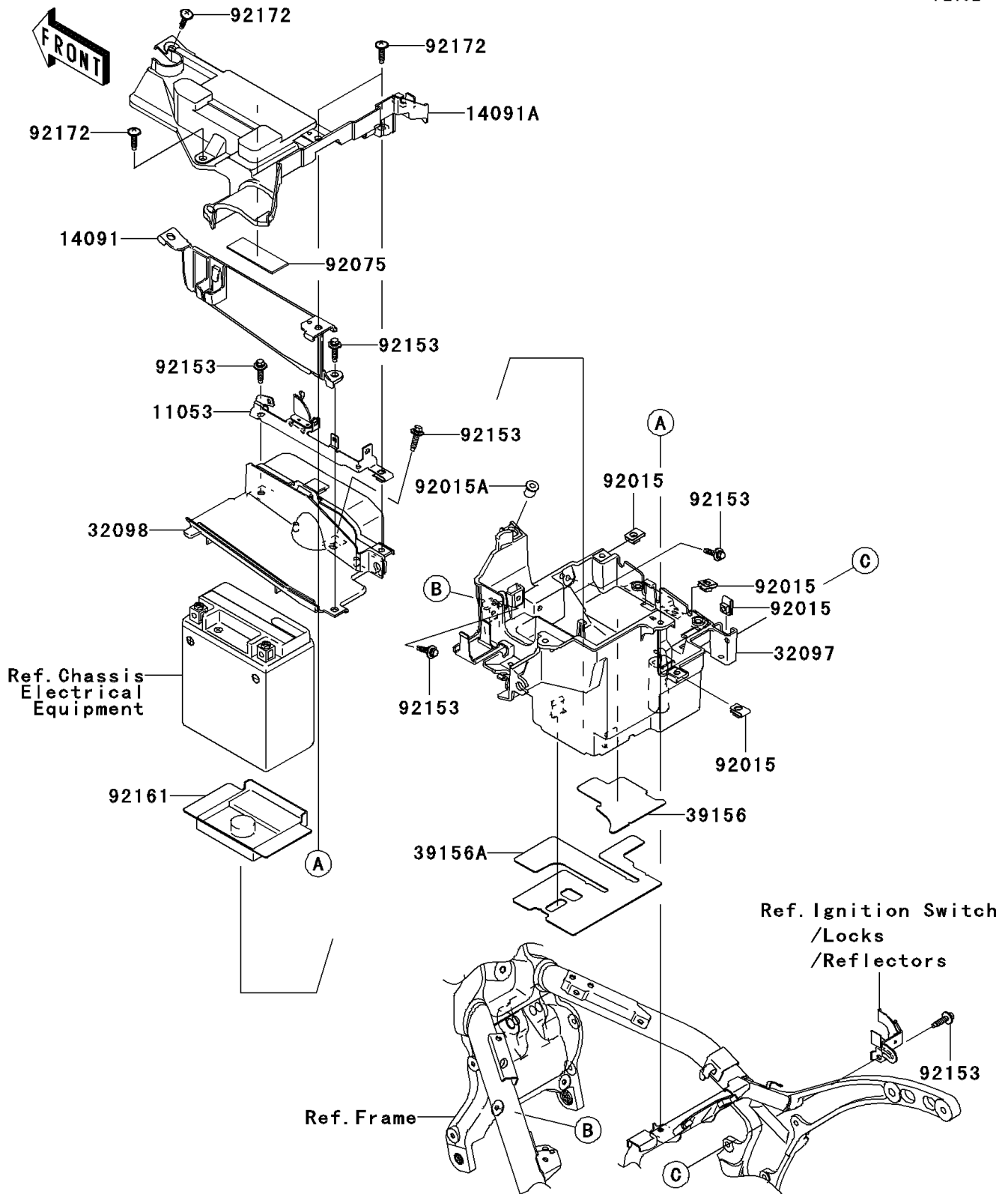

2006 Vulcan® 2000 PARTS LIST

Battery Case

ITEM NAME	PART NUMBER	QUANTITY
BRACKET,COUPLER (Ref # 11053)	11053-0905	1
COVER,TOOL CASE (Ref # 14091)	14091-0172	1
COVER,BATTERY (Ref # 14091A)	14091-0290	1
CASE-BATTERY (Ref # 32097)	32097-0005	1
CASE-TOOL (Ref # 32098)	32098-0007	1
PAD,BATTERY CASE (Ref # 39156)	39156-0047	1
PAD,BATTERY CASE (Ref # 39156A)	39156-0055	1
NUT,6MM (Ref # 92015)	92015-1602	1
NUT (Ref # 92015A)	92015-1700	1
DAMPER,BATTERY BAND (Ref # 92075)	92075-1903	1
BOLT,FLANGED,6X26.5 (Ref # 92153)	92153-0654	1
DAMPER,BATTERY (Ref # 92161)	92161-0114	1
SCREW,6X26 (Ref # 92172)	92172-0137	1