

2006 Vulcan® 2000 PARTS DIAGRAM

Oil Filter

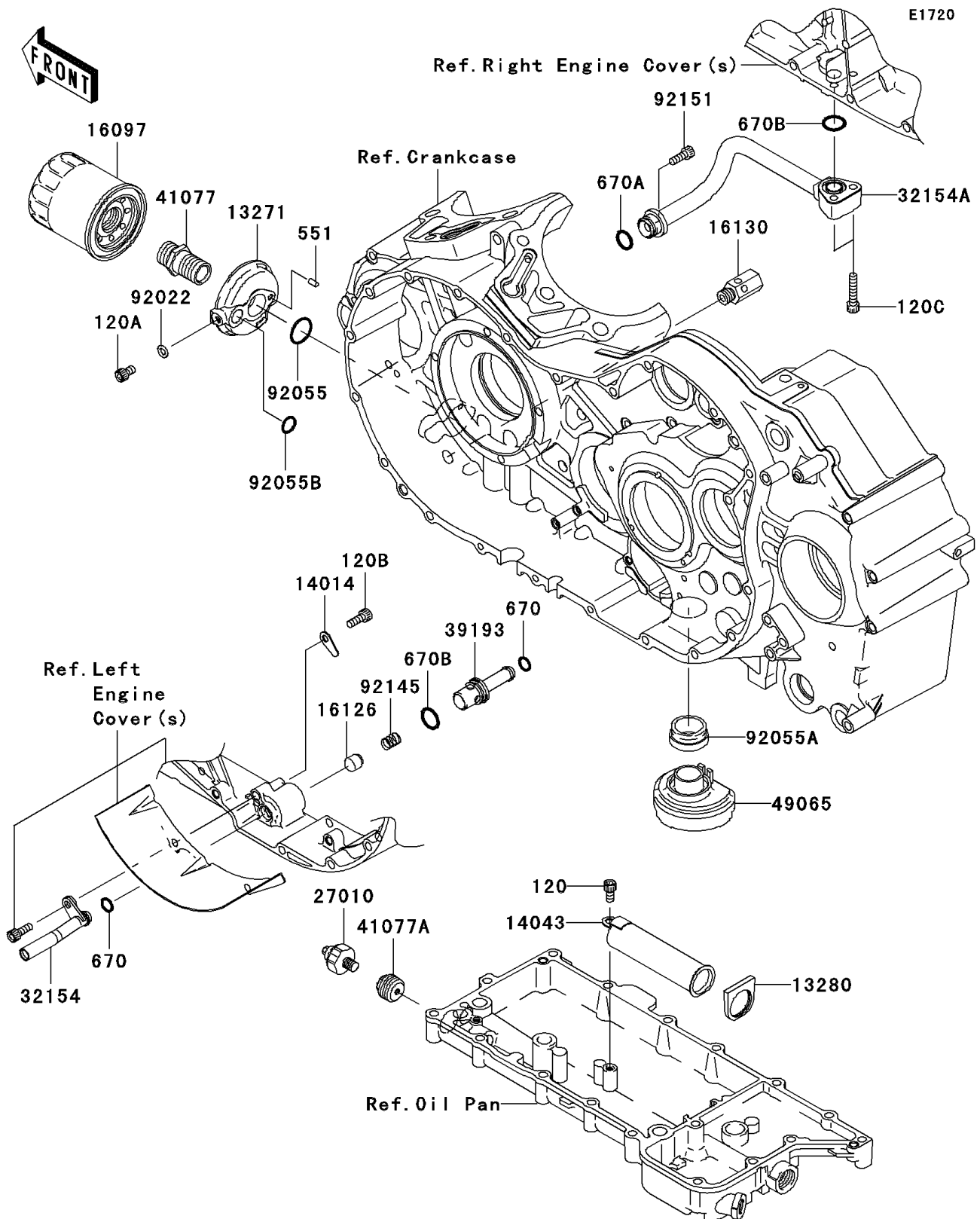

2006 Vulcan® 2000 PARTS LIST

Oil Filter

ITEM NAME	PART NUMBER	QUANTITY
BOLT-SOCKET,6X12 (Ref # 120)	120P0612	1
BOLT-SOCKET,6X10 (Ref # 120A)	120R0610	1
BOLT-SOCKET,6X16 (Ref # 120B)	120T0616	1
BOLT-SOCKET,6X30 (Ref # 120C)	120W0630	1
PIN-DOWEL (Ref # 551)	551R0408	1
O RING,10MM (Ref # 670)	670D1510	1
O RING,14MM (Ref # 670A)	670D2014	1
O RING,16MM (Ref # 670B)	670D2016	1
PLATE,FILTER BASE (Ref # 13271)	13271-0413	1
HOLDER (Ref # 13280)	13280-0008	1
PLATE-POSITION (Ref # 14014)	14014-0013	1
FILTER (Ref # 14043)	14043-0004	1
FILTER-ASSY-OIL (Ref # 16097)	16097-0004	1
VALVE,CHECK (Ref # 16126)	16126-0009	1
VALVE-ASSY-RELIEF (Ref # 16130)	16130-1058	1
SWITCH,OIL PRESSURE (Ref # 27010)	27010-1313	1
PIPE (Ref # 32154)	32154-0077	1
PIPE,CRANKCASE-MISSION COVER (Ref # 32154A)	32154-0427	1
PIPE-OIL,CLUTCH COVER-OIL PUMP (Ref # 39193)	39193-0016	1
ADAPTER (Ref # 41077)	41077-0003	1
ADAPTER (Ref # 41077A)	41077-0010	1
FILTER-OIL (Ref # 49065)	49065-0001	1
WASHER,6.2X11X1 (Ref # 92022)	92022-304	1
RING-O,20.8X1.9 (Ref # 92055)	92055-1259	1
RING-O,OIL FILTER (Ref # 92055A)	92055-1503	1
RING-O,12.3X1.9 (Ref # 92055B)	92055-1594	1
SPRING (Ref # 92145)	92145-0134	1
BOLT,SOCKET,6X16 (Ref # 92151)	92151-3770	1