

2006 Vulcan® 2000 PARTS DIAGRAM

Valve(s)

E1210

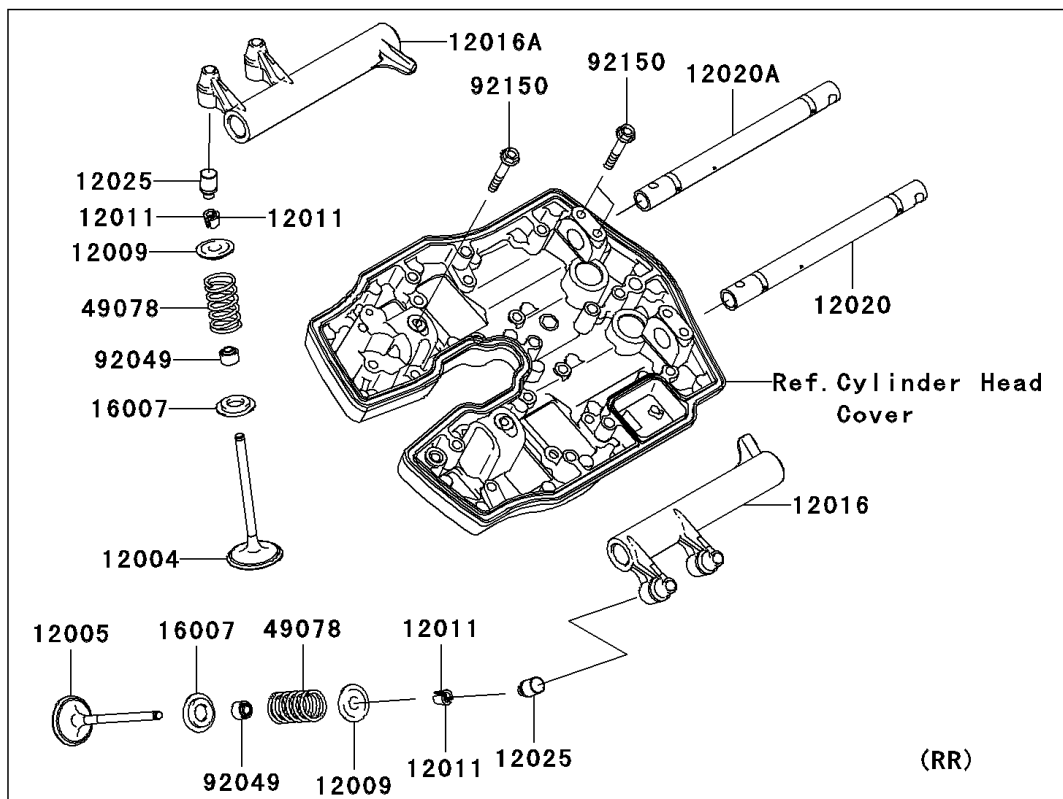
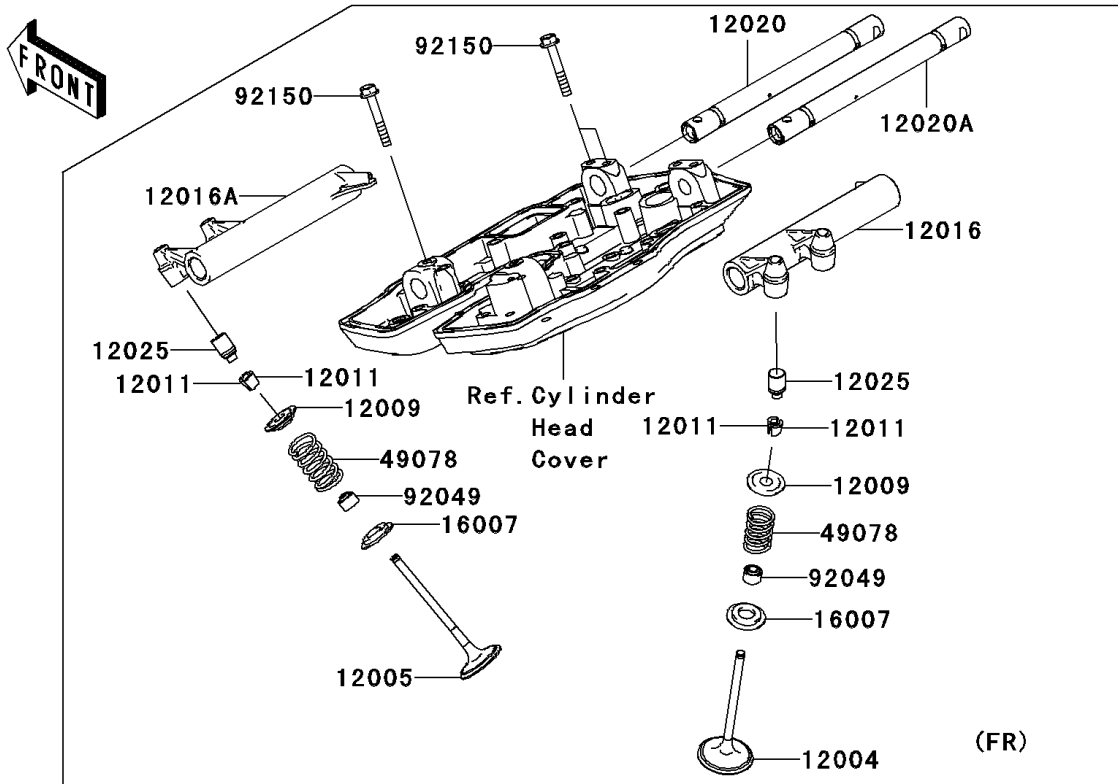

2006 Vulcan® 2000 PARTS LIST

Valve(s)

ITEM NAME	PART NUMBER	QUANTITY
VALVE-INTAKE (Ref # 12004)	12004-0001	1
VALVE-EXHAUST (Ref # 12005)	12005-0001	1
RETAINER-VALVE SPRING (Ref # 12009)	12009-0002	1
COLLET (Ref # 12011)	12011-0001	1
ARM-ROCKER (Ref # 12016)	12016-0015	1
ARM-ROCKER (Ref # 12016A)	12016-0016	1
SHAFT-ROCKER,EXHAUST (Ref # 12020)	12020-0001	1
SHAFT-ROCKER,INTAKE (Ref # 12020A)	12020-0002	1
ADJUSTER-LASH (Ref # 12025)	12025-1053	1
SEAT-SPRING (Ref # 16007)	16007-0001	1
SPRING-ENGINE VALVE (Ref # 49078)	49078-0001	1
SEAL-OIL,RVC2 6 10.5 9.4 (Ref # 92049)	92049-0009	1
BOLT,6X38 (Ref # 92150)	92150-1301	1