

2004 Vulcan® 2000 PARTS DIAGRAM

Cylinder Head Cover

E1112

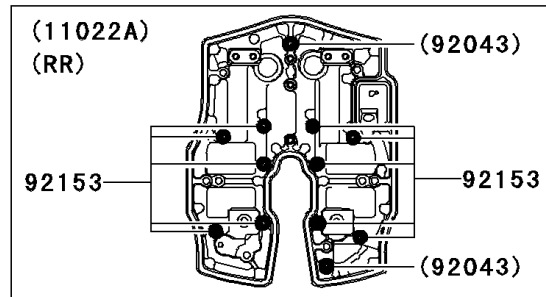
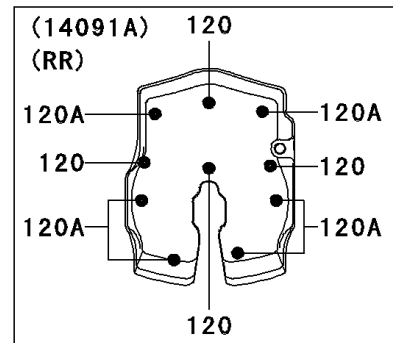
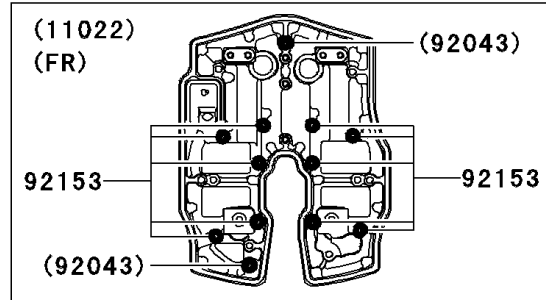
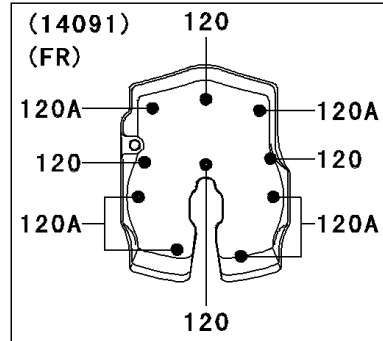
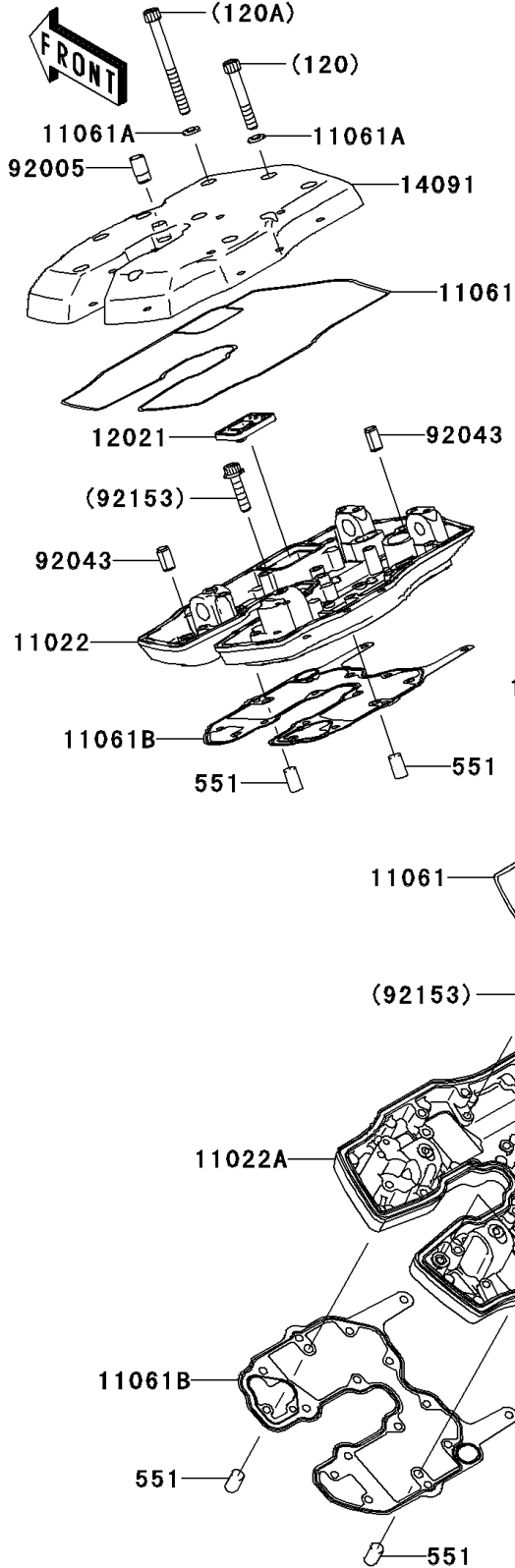

2004 Vulcan® 2000 PARTS LIST

Cylinder Head Cover

ITEM NAME	PART NUMBER	QUANTITY
BOLT-SOCKET,6X40 (Ref # 120)	120R0640	1
BOLT-SOCKET,6X65 (Ref # 120A)	120R0665	1
PIN-DOWEL,8X14 (Ref # 551)	551A0814	1
CASE-ROCKER,FR (Ref # 11022)	11022-0005	1
CASE-ROCKER,RR (Ref # 11022A)	11022-0006	1
GASKET,ROCKER CASE COVER (Ref # 11061)	11061-0007	1
GASKET (Ref # 11061A)	11061-0107	1
GASKET,ROCKER CASE (Ref # 11061B)	11061-0108	1
VALVE-ASSY-REED (Ref # 12021)	12021-1102	1
COVER,HEAD,FR (Ref # 14091)	14091-0029	1
COVER,HEAD,RR (Ref # 14091A)	14091-0030	1
FITTING (Ref # 92005)	92005-0002	1
PIN,6.2X8X14 (Ref # 92043)	92043-1263	1
BOLT,6X25 (Ref # 92153)	92153-0312	1