

2008 Vulcan® 2000 PARTS DIAGRAM

Radiator

E3032

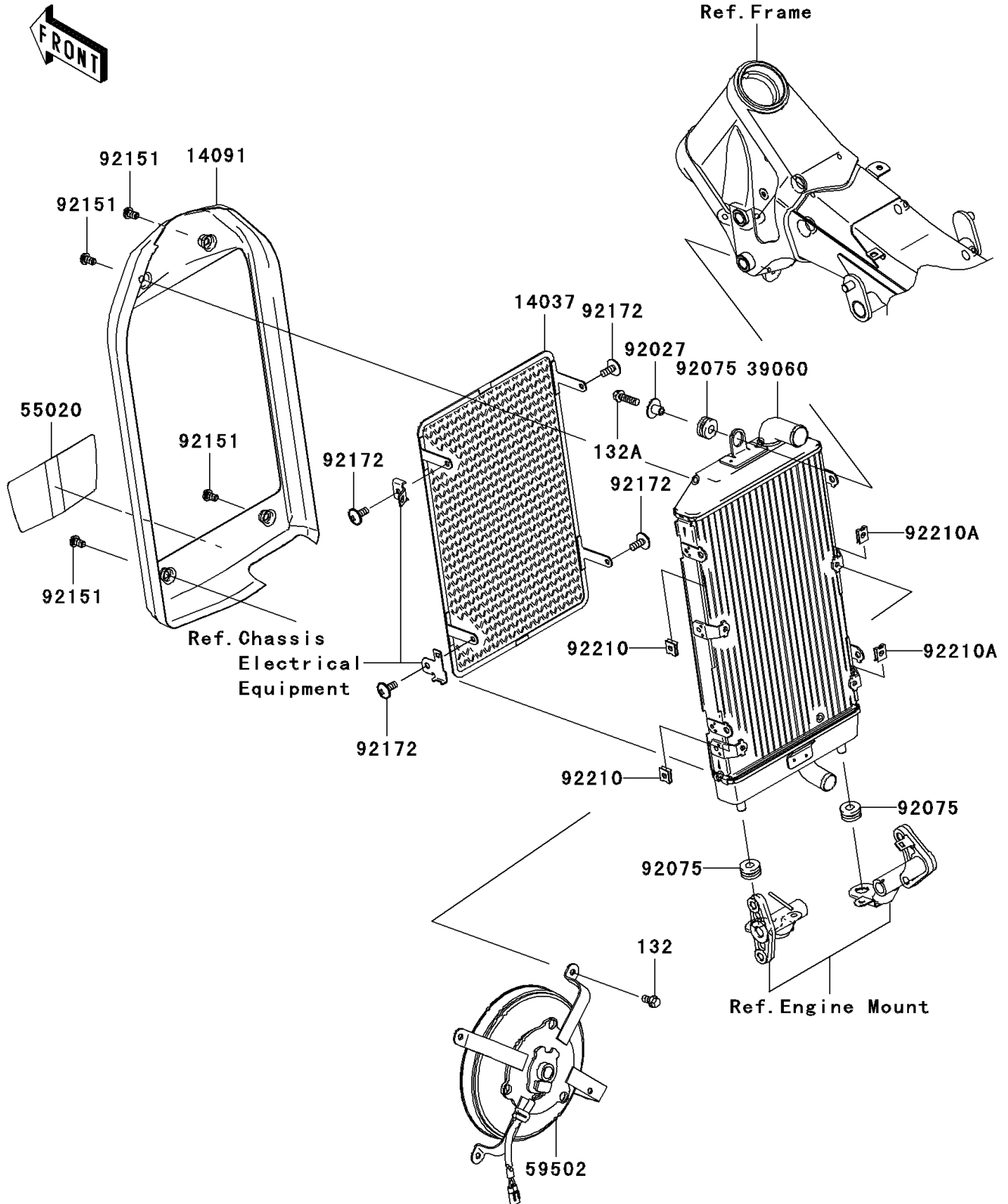

2008 Vulcan® 2000 PARTS LIST

Radiator

ITEM NAME	PART NUMBER	QUANTITY
BOLT-FLANGED-SMALL,6X10 (Ref # 132)	132BB0610	1
BOLT-FLANGED-SMALL,6X20 (Ref # 132A)	132BB0620	1
SCREEN (Ref # 14037)	14037-0005	1
COVER,RADIATOR,F.S.BLACK (Ref # 14091)	14091-0876-18R	1
RADIATOR (Ref # 39060)	39060-0018	1
GUARD (Ref # 55020)	55020-0100	1
FAN-ASSY (Ref # 59502)	59502-0035	1
COLLAR,L=13.1,BLACK (Ref # 92027)	92027-1450	1
DAMPER (Ref # 92075)	92075-1690	1
BOLT,6X10 (Ref # 92151)	92151-1809	1
SCREW,6X14 (Ref # 92172)	92172-0004	1
NUT (Ref # 92210)	92210-1125	1
NUT (Ref # 92210A)	92210-1323	1