

## 2006 KX™250F PARTS DIAGRAM

Swingarm

F2141

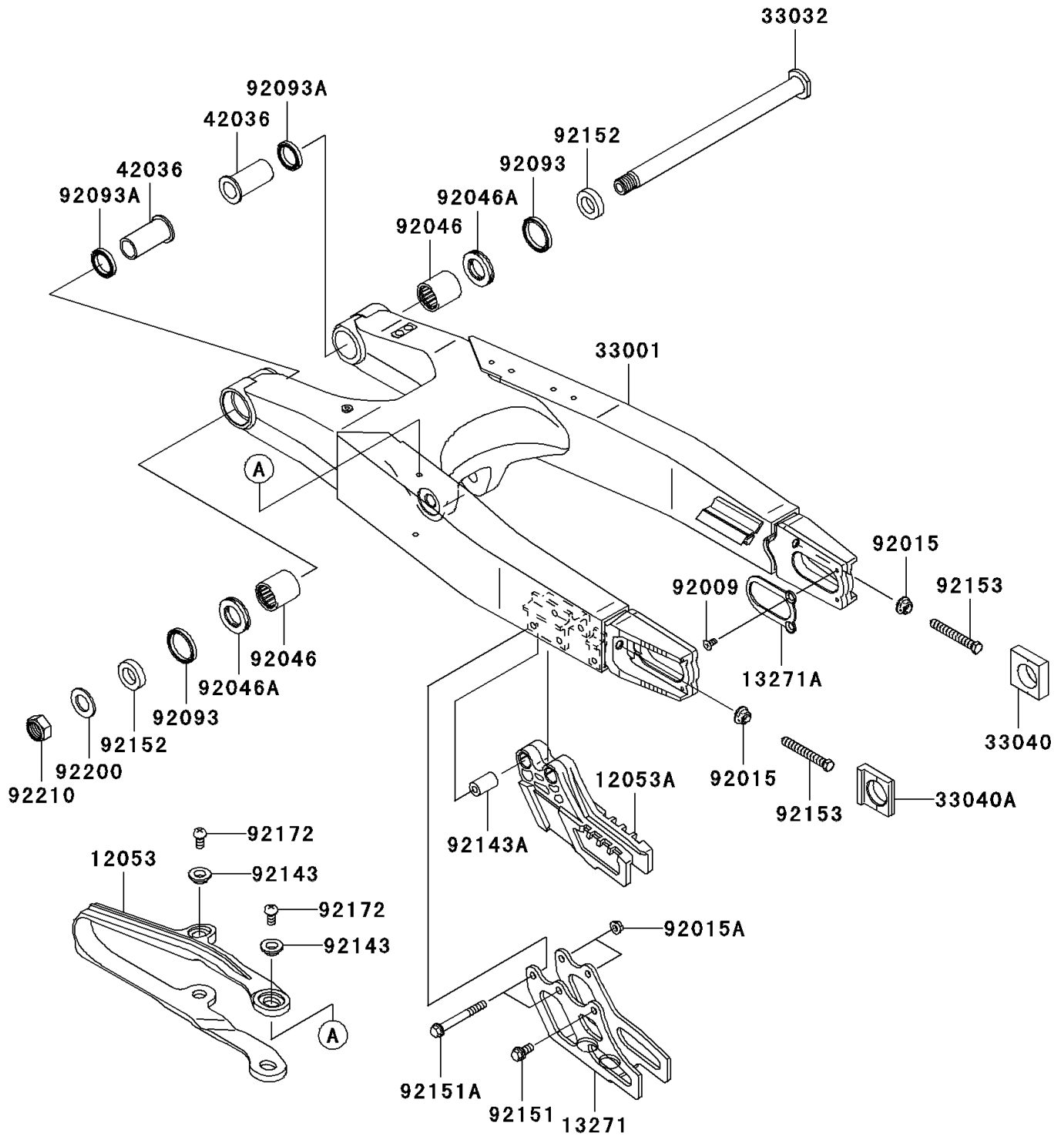

## 2006 KX™250F PARTS LIST

Swingarm

ITEM NAME	PART NUMBER	QUANTITY
GUIDE-CHAIN,DRIVE,FR (Ref # 12053)	12053-0053	1
GUIDE-CHAIN (Ref # 12053A)	12053-0061	1
PLATE,CHAIN GUIDE (Ref # 13271)	13271-0593	1
PLATE,AXLE (Ref # 13271A)	13271-1833	1
ARM-COMP-SWING (Ref # 33001)	33001-0069	1
SHAFT-SWING ARM (Ref # 33032)	33032-0012	1
ADJUSTER-CHAIN,RH (Ref # 33040)	33040-0020	1
ADJUSTER-CHAIN,LH (Ref # 33040A)	33040-1189	1
SLEEVE,SWING ARM,L=47.5 (Ref # 42036)	42036-0019	1
SCREW,5X10 (Ref # 92009)	92009-1828	1
NUT,FLANGED,8MM (Ref # 92015)	92015-1014	1
NUT,FLANGED,6MM (Ref # 92015A)	92015-1078	1
BEARING-NEEDLE,TA2230Z (Ref # 92046)	92046-1174	1
BEARING-NEEDLE,NTBR22356E01 (Ref # 92046A)	92046-1240	1
SEAL,SD029X35X4.5 (Ref # 92093)	92093-1434	1
SEAL,SD022X29X5 (Ref # 92093A)	92093-1435	1
COLLAR (Ref # 92143)	92143-1676	1
COLLAR,6.5X14X24 (Ref # 92143A)	92143-1867	1
BOLT,6X12 (Ref # 92151)	92151-1133	1
BOLT,6X50 (Ref # 92151A)	92151-1234	1
COLLAR,17.1X29X6 (Ref # 92152)	92152-0292	1
BOLT,8X56 (Ref # 92153)	92153-0620	1
SCREW,5X8 (Ref # 92172)	92172-0119	1
WASHER,17.2X30X2.3 (Ref # 92200)	92200-0285	1
NUT,LOCK,16MM (Ref # 92210)	92210-0285	1