

2001 KX™250 PARTS DIAGRAM

Gear Change Drum/Shift Fork(s)

E1362

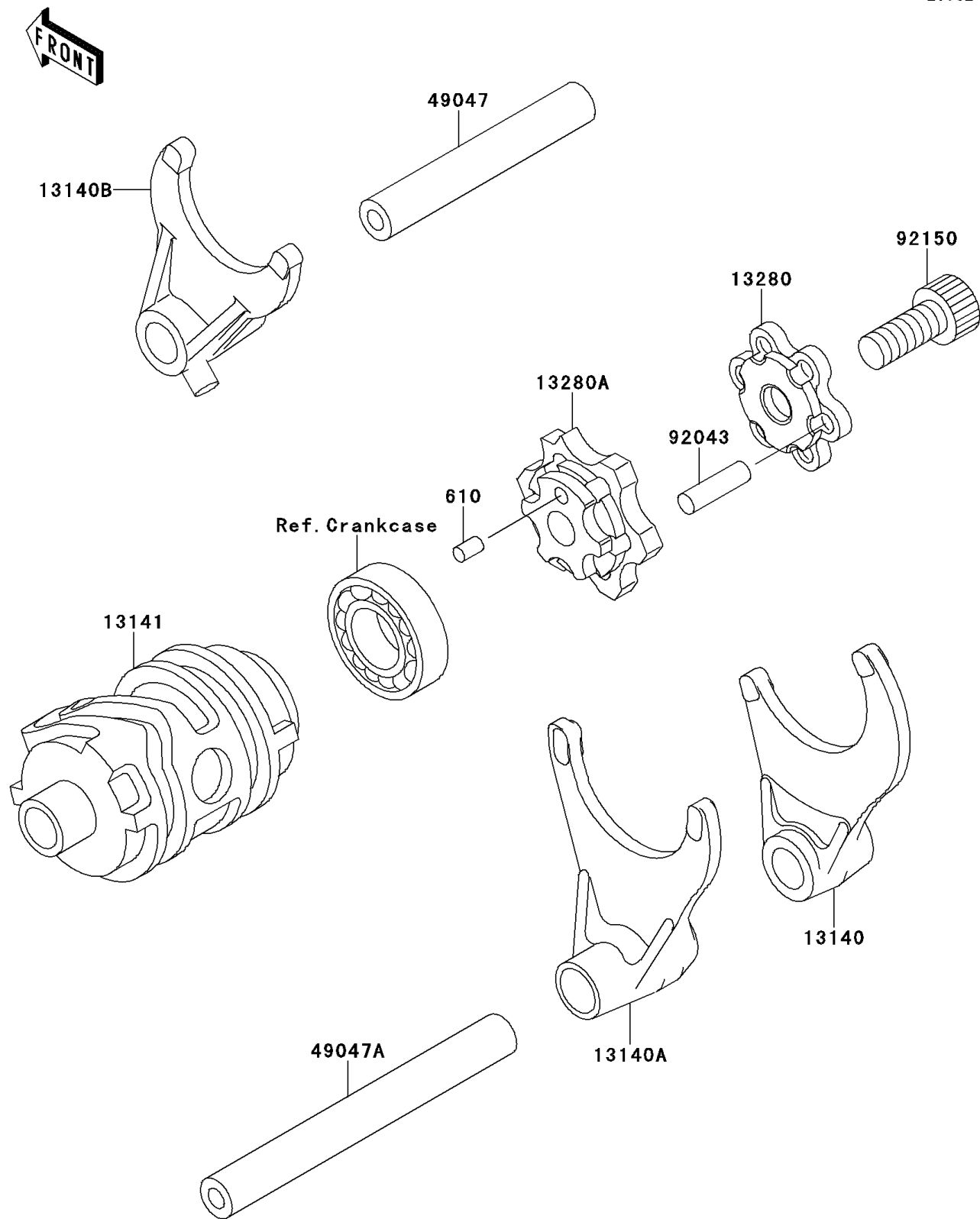

2001 KX™250 PARTS LIST

Gear Change Drum/Shift Fork(s)

ITEM NAME	PART NUMBER	QUANTITY
ROLLER,4X8 (Ref # 610)	610A0408	1
FORK-SHIFT,LOW (Ref # 13140)	13140-1248	1
FORK-SHIFT,2ND&3RD (Ref # 13140A)	13140-1249	1
FORK-SHIFT,4TH&TOP (Ref # 13140B)	13140-1250	1
DRUM-CHANGE (Ref # 13141)	13141-1200	1
HOLDER (Ref # 13280)	13280-1182	1
HOLDER (Ref # 13280A)	13280-1223	1
ROD-SHIFT,L=64.5 (Ref # 49047)	49047-1107	1
ROD-SHIFT,L=90 (Ref # 49047A)	49047-1108	1
PIN,17.9X5.0 (Ref # 92043)	92043-1444	1
BOLT,SOCKET,8X30 (Ref # 92150)	92150-1604	1