

2001 KX™250 PARTS DIAGRAM

Crankshaft/Piston(s)

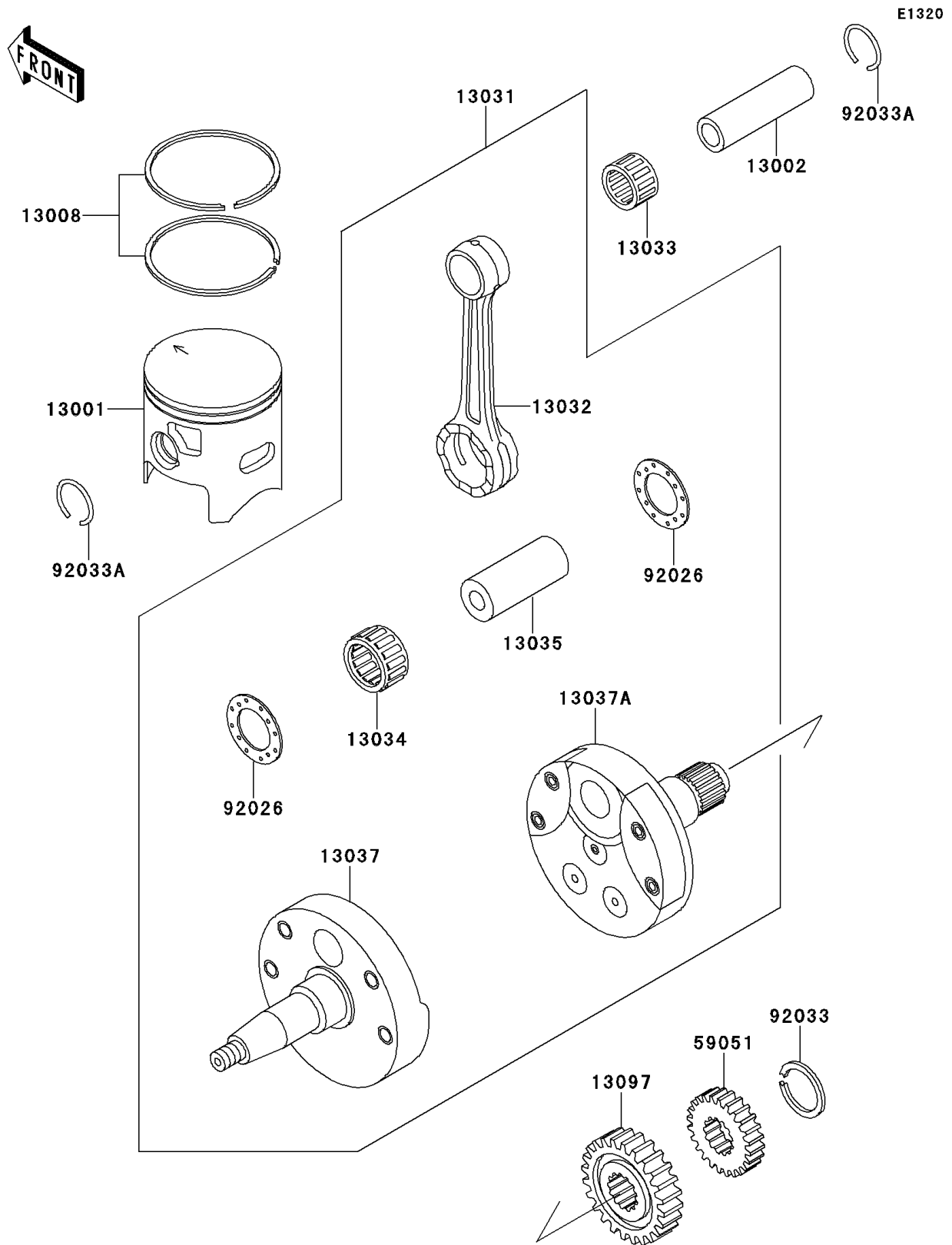

2001 KX™250 PARTS LIST

Crankshaft/Piston(s)

ITEM NAME	PART NUMBER	QUANTITY
PISTON-ENGINE (Ref # 13001)	13001-1582	1
PIN-PISTON (Ref # 13002)	13002-1098	1
RING-SET-PISTON (Ref # 13008)	13008-1173	1
CRANKSHAFT-COMP (Ref # 13031)	13031-1482	1
ROD-CONNECTING (Ref # 13032)	13032-1263	1
BEARING-NEEDLE,KBK18X22X23.8X (Ref # 13033)	13033-1010	1
BEARING-BIG END,B4 (Ref # 13034)	13034-1108	1
PIN-CRANK (Ref # 13035)	13035-1089	1
CRANKSHAFT,LH (Ref # 13037)	13037-1611	1
CRANKSHAFT,RH (Ref # 13037A)	13037-1613	1
GEAR-PRIMARY SPUR,20T (Ref # 13097)	13097-1402	1
GEAR-SPUR,27T (Ref # 59051)	59051-1248	1
SPACER (Ref # 92026)	92026-1547	1
RING-SNAP,20X25.5X1.2 (Ref # 92033)	92033-025	1
RING-SNAP,PISTON PIN (Ref # 92033A)	92033-1267	1