

2000 KX™250 PARTS DIAGRAM

Ignition System

E1830

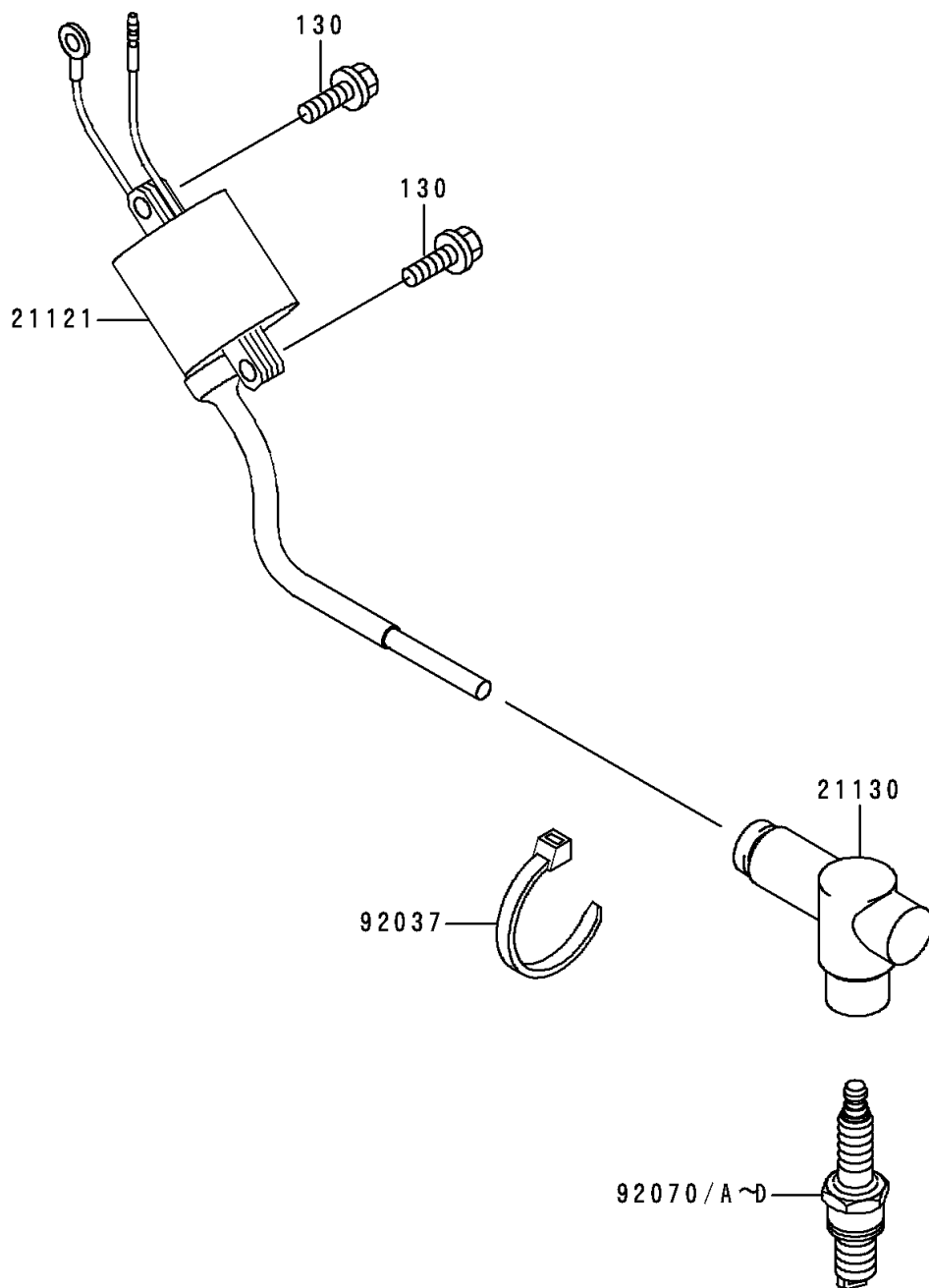

2000 KX™250 PARTS LIST

Ignition System

ITEM NAME	PART NUMBER	QUANTITY
BOLT-FLANGED (Ref # 130)	130G0520	1
COIL-IGNITION (Ref # 21121)	21121-1281	1
CAP-SPARK PLUG (Ref # 21130)	21130-1077	1
CLAMP (Ref # 92037)	92037-1173	1
PLUG-SPARK,BR8EVX(NGK),SOLID (Ref # 92070)	92070-1231	1
PLUG-SPARK,R6385-8P(NGK) (Ref # 92070A)	92070-1235	1
PLUG-SPARK,R6252E-9(NGK) (Ref # 92070B)	92070-1238	1
PLUG-SPARK,R6252E-8(NGK) (Ref # 92070C)	92070-1243	1
PLUG-SPARK,BR7EVX(NGK) (Ref # 92070D)	92070-1249	1