

2000 KX™250 PARTS DIAGRAM

Air Cleaner

E1130

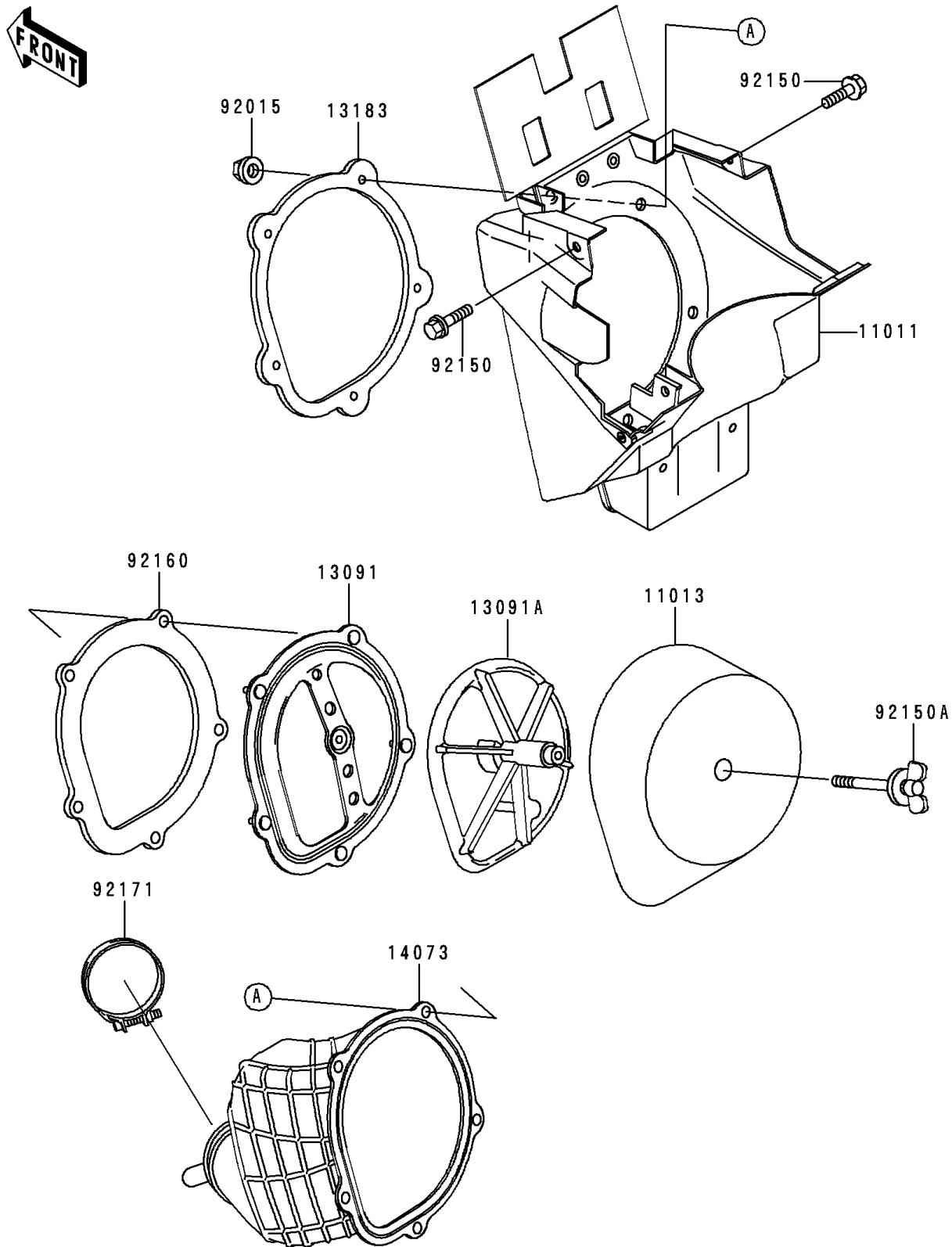

2000 KX™250 PARTS LIST

Air Cleaner

ITEM NAME	PART NUMBER	QUANTITY
CASE-AIR FILTER,BLACK (Ref # 11011)	11011-1557-6D	1
ELEMENT-AIR FILTER (Ref # 11013)	11013-1264	1
HOLDER (Ref # 13091)	13091-1664	1
HOLDER,ELEMENT (Ref # 13091A)	13091-1708	1
PLATE,DUCT FITTING (Ref # 13183)	13183-1530	1
DUCT,AIR FILTER (Ref # 14073)	14073-1743	1
NUT,FLANGED,5MM (Ref # 92015)	92015-1259	1
BOLT,FLANGED,6X16 (Ref # 92150)	92150-1506	1
BOLT,WING (Ref # 92150A)	92150-1565	1
DAMPER,DUCT SEAL (Ref # 92160)	92160-1196	1
CLAMP,AIR FILTER (Ref # 92171)	92171-1066	1