

1998 KX™250 PARTS DIAGRAM

Kickstarter Mechanism

E1340

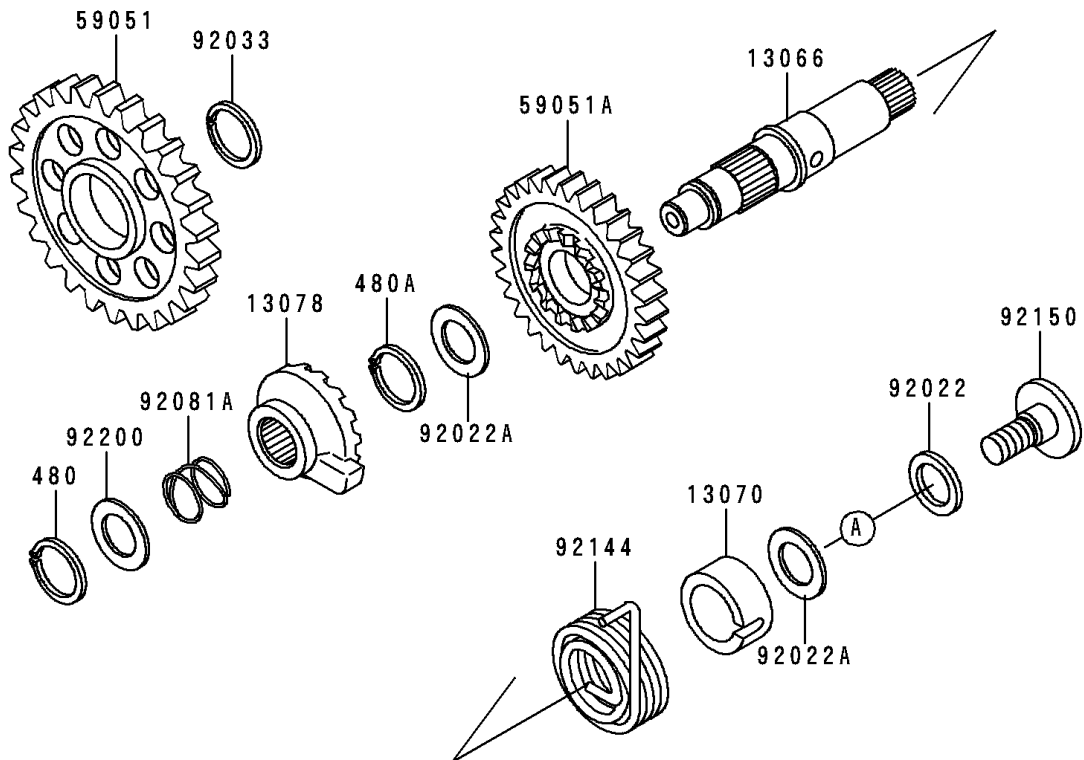
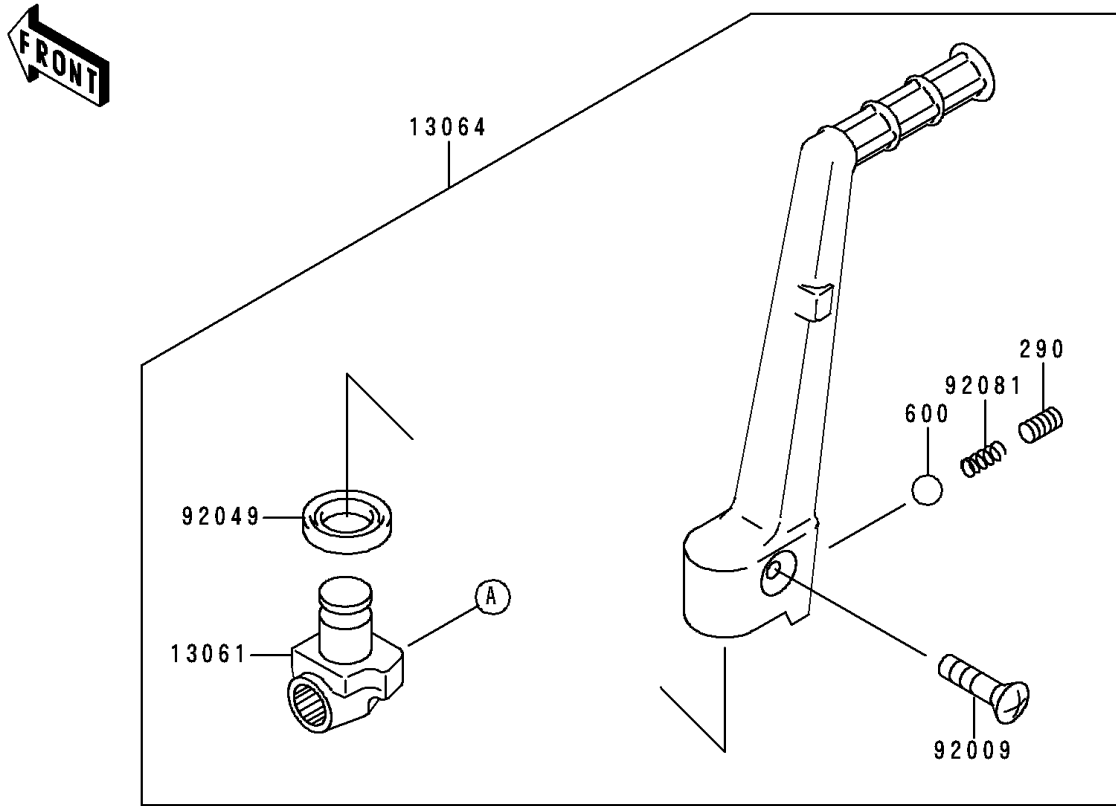

1998 KX™250 PARTS LIST

Kickstarter Mechanism

ITEM NAME	PART NUMBER	QUANTITY
SCREW-SET-SOCKET (Ref # 290)	290P0812	1
CIRCLIP-TYPE-C,16MM (Ref # 480)	480J1600	1
CIRCLIP-TYPE-C,18MM (Ref # 480A)	480J1800	1
BALL-STEEL,1/4" (Ref # 600)	600A0800	1
BOSS,KICK PEDAL (Ref # 13061)	13061-1491	1
LEVER-ASSY-KICK,KICK PEDAL (Ref # 13064)	13064-1178	1
SHAFT-KICK (Ref # 13066)	13066-1091	1
GUIDE,KICK SPRING (Ref # 13070)	13070-1063	1
RATCHET (Ref # 13078)	13078-1063	1
GEAR,KICKSTARTER IDLE,26T (Ref # 59051)	59051-1271	1
GEAR-SPUR,KICK STARTER (Ref # 59051A)	59051-1339	1
SCREW,6X30 (Ref # 92009)	92009-1590	1
WASHER (Ref # 92022)	92022-1944	1
WASHER,18.3X22X0.5 (Ref # 92022A)	92022-271	1
RING-SNAP,18MM (Ref # 92033)	92033-029	1
SEAL-OIL,KICK PEDAL (Ref # 92049)	92049-1387	1
SPRING,KICK PEDAL (Ref # 92081)	92081-020	1
SPRING,RATCHET (Ref # 92081A)	92081-122	1
SPRING,KICKSTARTER (Ref # 92144)	92144-1076	1
BOLT,KICK PEDAL (Ref # 92150)	92150-1800	1
WASHER,KICKSHAFT (Ref # 92200)	92200-1209	1