

1996 KX™250 PARTS DIAGRAM

Swingarm

F2141

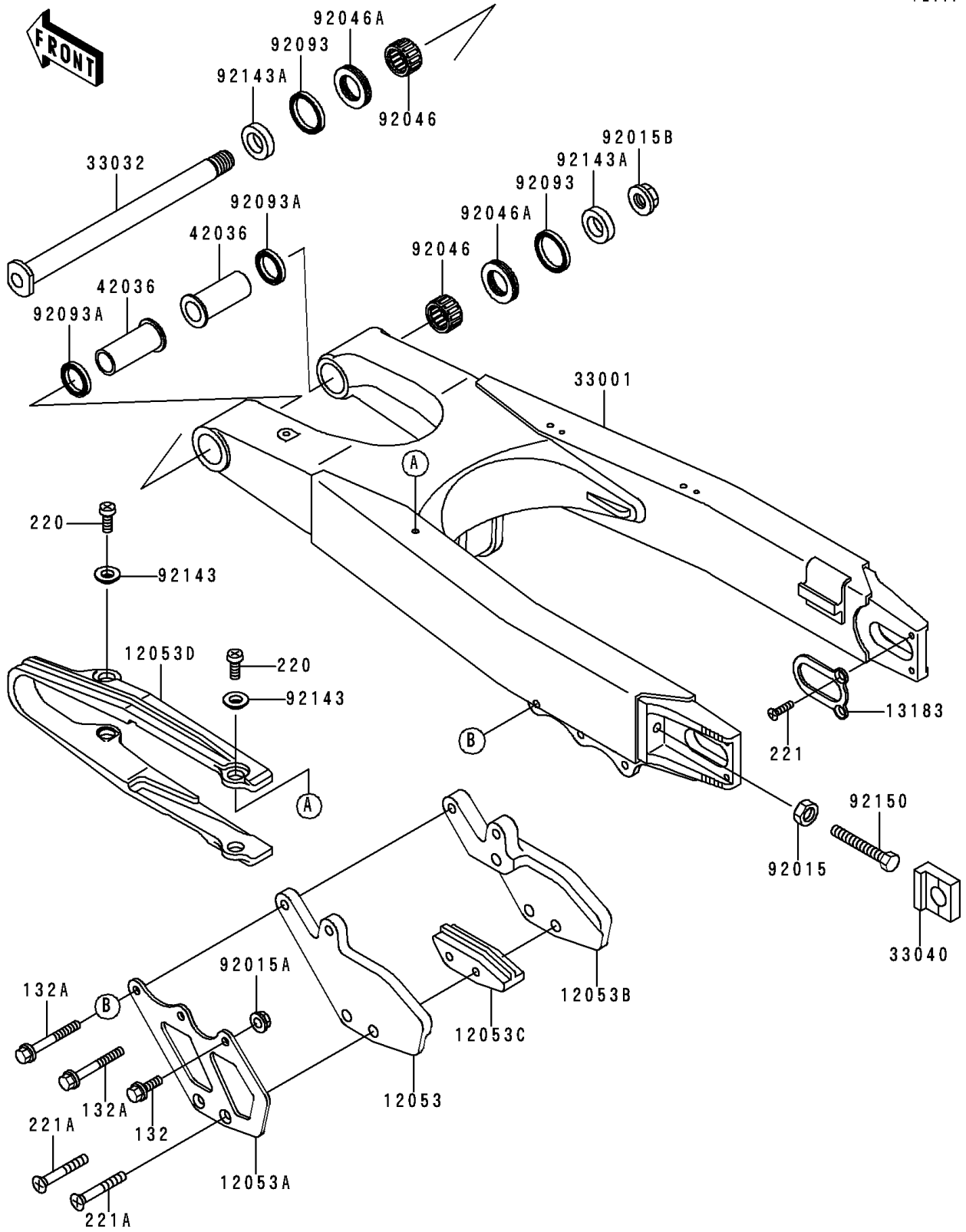

1996 KX™250 PARTS LIST

Swingarm

ITEM NAME	PART NUMBER	QUANTITY
BOLT-FLANGED-SMALL (Ref # 132)	132G0616	1
BOLT-FLANGED-SMALL (Ref # 132A)	132G0635	1
SCREW-PAN-CROS,5X8 (Ref # 220)	220B0508	1
SCREW-CSK-CROS (Ref # 221)	221B0510	1
SCREW-CSK-CROS,6X45 (Ref # 221A)	221B0645	1
GUIDE-CHAIN,RR,INSIDE (Ref # 12053)	12053-1234	1
GUIDE-CHAIN,RR,OUTSIDE (Ref # 12053A)	12053-1235	1
GUIDE-CHAIN,RR,OUTSIDE (Ref # 12053B)	12053-1236	1
GUIDE-CHAIN,DRIVE,RR,INSIDE (Ref # 12053C)	12053-1270	1
GUIDE-CHAIN,DRIVE,FR (Ref # 12053D)	12053-1336	1
PLATE (Ref # 13183)	13183-1867	1
ARM-COMP-SWING,F.SILVER (Ref # 33001)	33001-1487-TX	1
SHAFT-SWING ARM (Ref # 33032)	33032-1172	1
ADJUSTER-CHAIN (Ref # 33040)	33040-1136	1
SLEEVE,SWING ARM,L=54 (Ref # 42036)	42036-1326	1
NUT,FLANGED,8MM (Ref # 92015)	92015-1014	1
NUT,FLANGED,6MM (Ref # 92015A)	92015-1078	1
NUT,FLANGED,16MM (Ref # 92015B)	92015-1316	1
BEARING-NEEDLE,TA2230Z (Ref # 92046)	92046-1174	1
BEARING-NEEDLE,NTBR22356E01 (Ref # 92046A)	92046-1240	1
SEAL,SO 29 35 4 (Ref # 92093)	92093-1384	1
SEAL,SO 22 29 4 (Ref # 92093A)	92093-1385	1
COLLAR (Ref # 92143)	92143-1676	1
COLLAR,17.1X29X7 (Ref # 92143A)	92143-1777	1
BOLT,8X55 (Ref # 92150)	92150-1385	1