

2001 KX™125 PARTS DIAGRAM

Ignition System

E1830

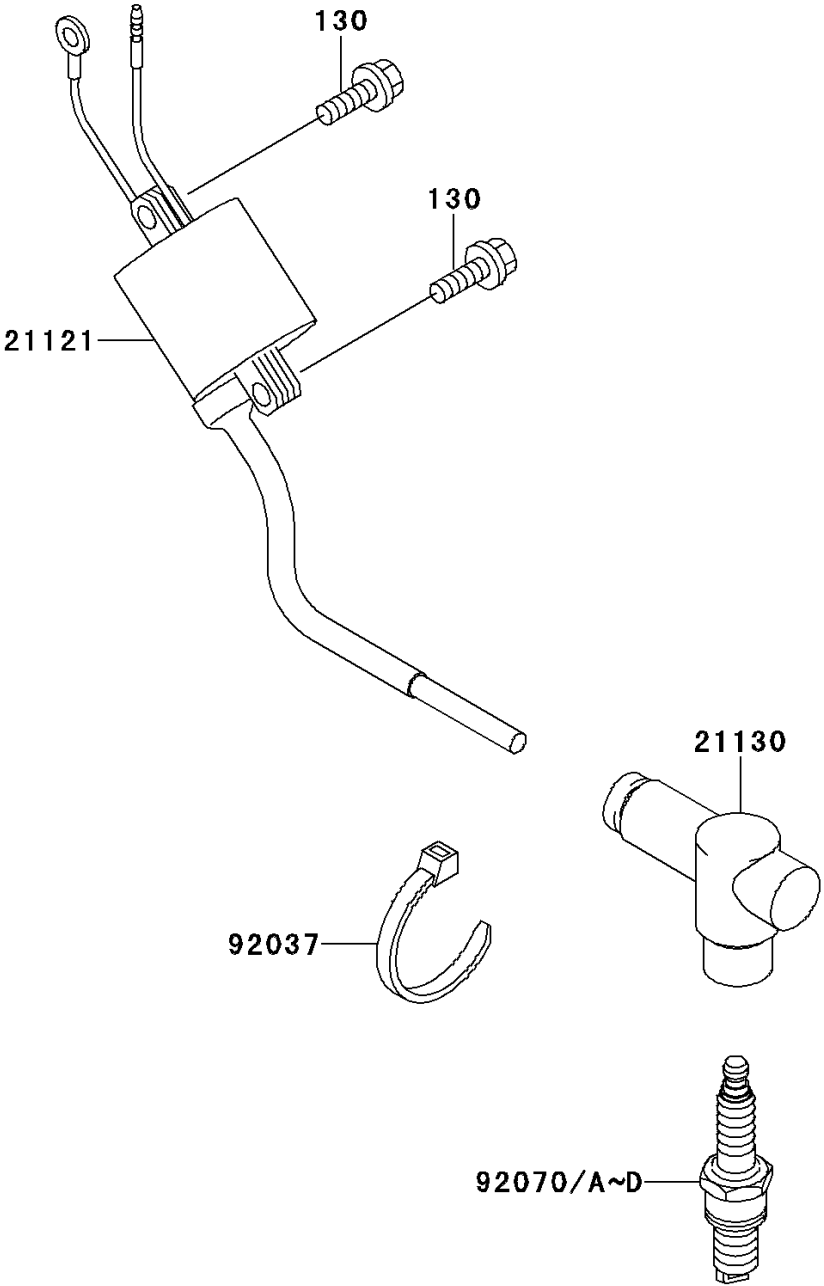

2001 KX™125 PARTS LIST

Ignition System

ITEM NAME	PART NUMBER	QUANTITY
BOLT-FLANGED (Ref # 130)	130G0520	1
COIL-IGNITION (Ref # 21121)	21121-1282	1
CAP-SPARK PLUG (Ref # 21130)	21130-1077	1
CLAMP (Ref # 92037)	92037-1173	1
PLUG-SPARK,W31ESR-ZU(ND) (Ref # 92070)		1
PLUG-SPARK,BR9EVX(NGK),SOLID (Ref # 92070A)	92070-1228	1
PLUG-SPARK,R6385-9P(NGK) (Ref # 92070B)	92070-1236	1
PLUG-SPARK,R6252E-9(NGK) (Ref # 92070C)	92070-1238	1
PLUG-SPARK,R6252K-105NGK,SOLID (Ref # 92070D)	92070-1241	1