

## 1992 KX™125 PARTS DIAGRAM

Rear Hub

F2240

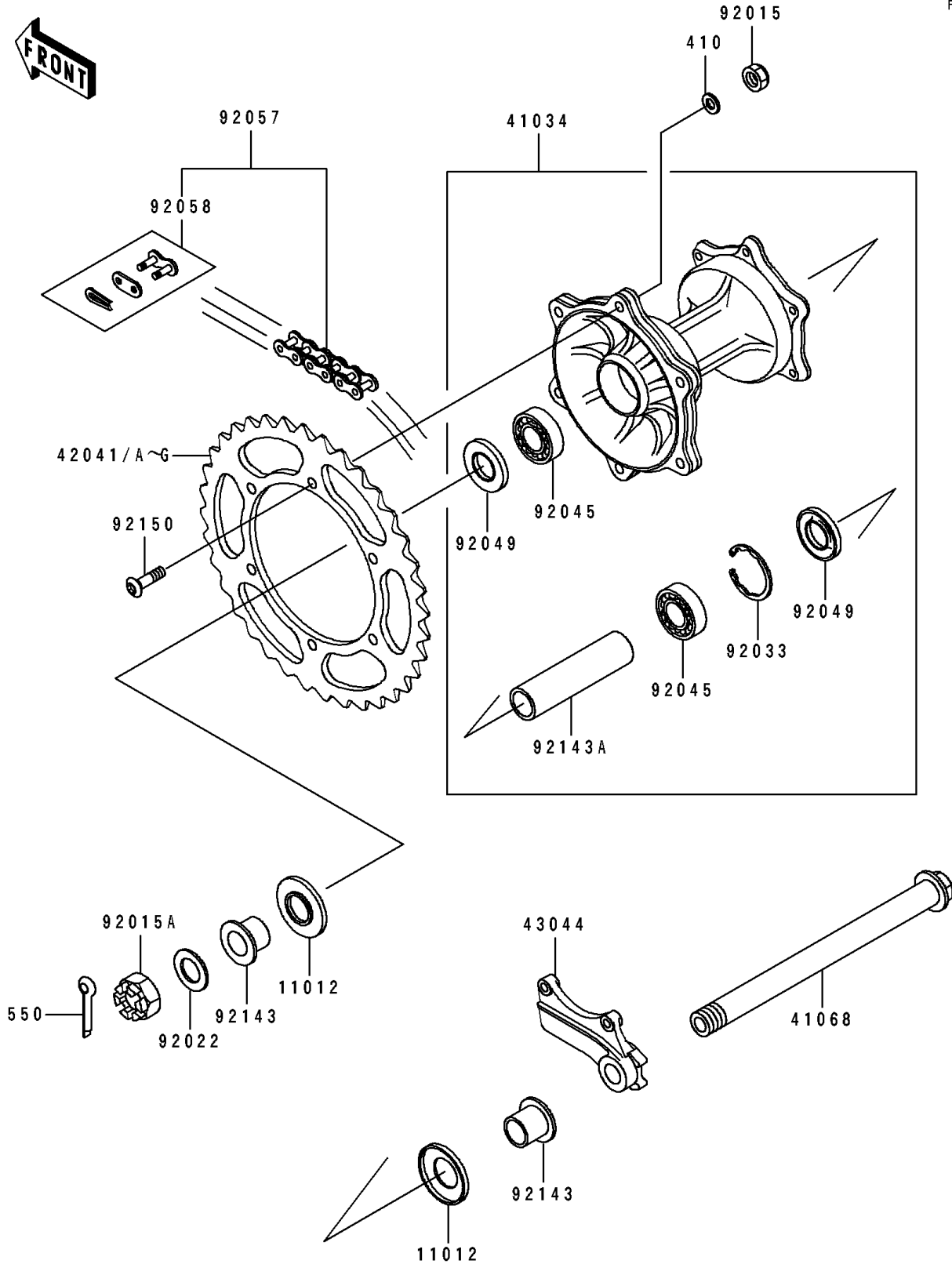

## 1992 KX™125 PARTS LIST

Rear Hub

ITEM NAME	PART NUMBER	QUANTITY
CAP,REAR AXLE (Ref # 11012)	11012-1581	1
DRUM-ASSY,REAR BRAKE (Ref # 41034)	41034-1205	1
AXLE,RR (Ref # 41068)	41068-1299	1
SPROCKET-HUB,51T,AL (Ref # 42041)	42041-1104	1
SPROCKET-HUB,50T,AL (Ref # 42041A)	42041-1255	1
SPROCKET-HUB,49T,AL (Ref # 42041B)	42041-1256	1
SPROCKET-HUB,48T,AL (Ref # 42041C)	42041-1257	1
SPROCKET-HUB,47T,AL (Ref # 42041D)	42041-1258	1
SPROCKET-HUB,48T (Ref # 42041E)	42041-1383	1
SPROCKET-HUB,49T (Ref # 42041F)	42041-1384	1
SPROCKET-HUB,50T (Ref # 42041G)	42041-1408	1
HOLDER-COMP-CALIPER (Ref # 43044)	43044-1092	1
NUT,LOCK,8MM (Ref # 92015)	92015-1124	1
NUT,CASTLE,20MM (Ref # 92015A)	92015-1804	1
WASHER,20.1X34X2.0 (Ref # 92022)	92022-1994	1
RING-SNAP,42MM (Ref # 92033)	92033-1041	1
BEARING-BALL,6004X8JRLLX2/3A (Ref # 92045)	92045-1239	1
SEAL-OIL,BJNC2 25425 (Ref # 92049)	92049-1203	1
CHAIN,DRIVE,DID520DS6X112L (Ref # 92057)	92057-1244	1
JOINT-CHAIN,DRIVE (Ref # 92058)	92058-1057	1
COLLAR,RR AXLE,L=20 (Ref # 92143)	92143-1356	1
COLLAR,RR BRAKE DRUM,L=105 (Ref # 92143A)	92143-1402	1
BOLT,SOCKET,8X28 (Ref # 92150)	92150-1196	1
WASHER-PLAIN-SMALL,8MM (Ref # 410)	410B0800	1
PIN-COTTER,3.0X25 (Ref # 550)	550D3025	1