

2019 Ninja H2™ SX SE+ PARTS DIAGRAM

Transmission

E1361

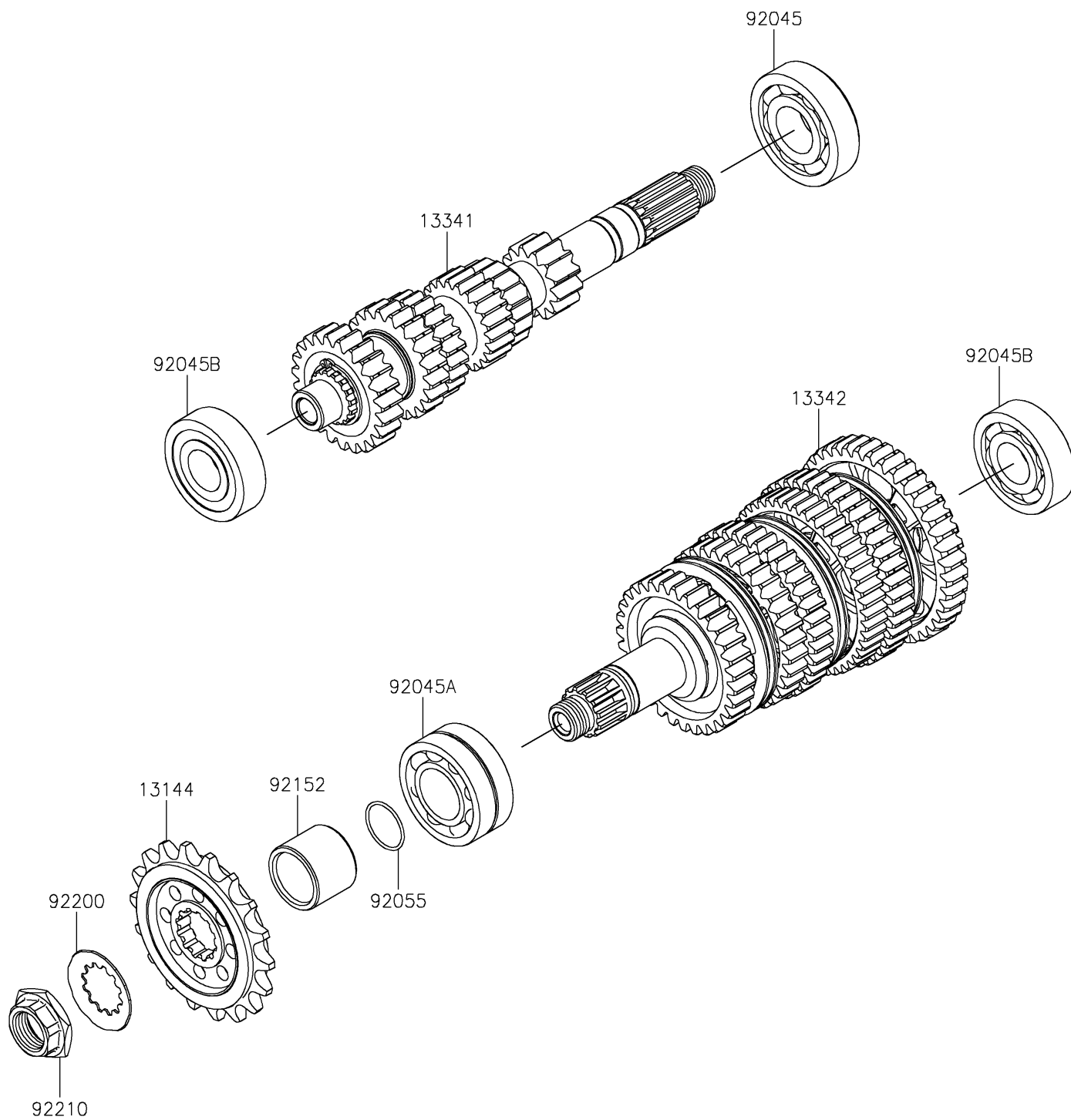

2019 Ninja H2™ SX SE+ PARTS LIST

Transmission

ITEM NAME	PART NUMBER	QUANTITY
SPROCKET-OUTPUT,18T (Ref # 13144)	13144-0575	1
TRANSMISSION-ASSY INPUT (Ref # 13341)	13341-0640	1
TRANSMISSION-ASSY OUTPUT (Ref # 13342)	13342-0642	1
BEARING-BALL,830045-5SH2 (Ref # 92045)	92045-0047	1
BEARING-BALL,DAC2857NSSH6CS9 (Ref # 92045A)	92045-0049	1
BEARING-BALL,63/22LU (Ref # 92045B)	92045-0156	1
RING-O,23.5X1.5 (Ref # 92055)	92055-0823	1
COLLAR,27.5X35X27.7 (Ref # 92152)	92152-1954	1
WASHER,23.9X45X1.0 (Ref # 92200)	92200-0260	1
NUT,20MM (Ref # 92210)	92210-0942	1