

2017 MULE PRO-DXT™ EPS PARTS DIAGRAM

Fuel Tank

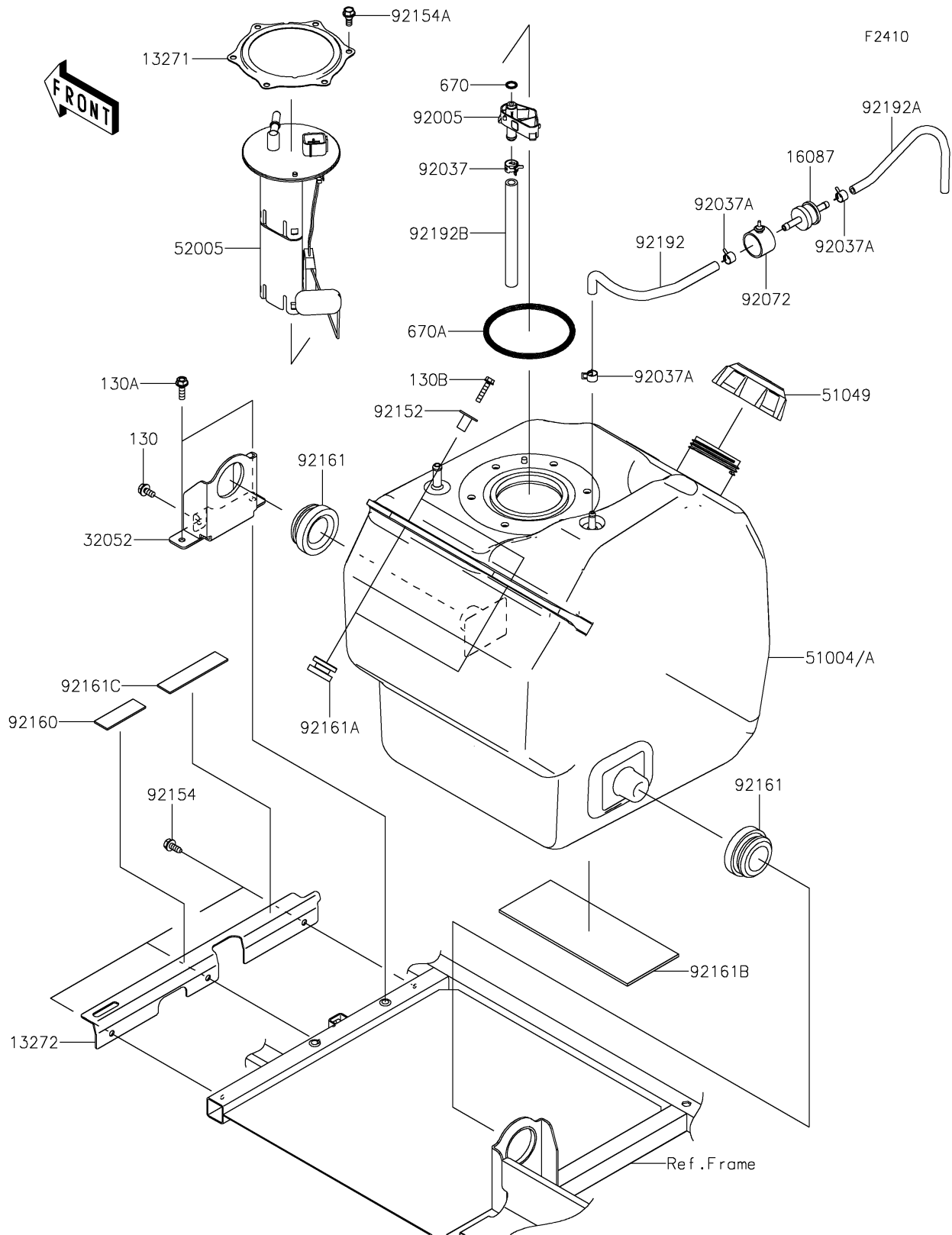

2017 MULE PRO-DXT™ EPS PARTS LIST

Fuel Tank

ITEM NAME	PART NUMBER	QUANTITY
BOLT-FLANGED,6X12 (Ref # 130)	130BA0612	1
BOLT-FLANGED,6X20 (Ref # 130A)	130BA0620	1
BOLT-FLANGED,6X30 (Ref # 130B)	130BA0630	1
PLATE (Ref # 13271)	13271-0980	1
PLATE (Ref # 13272)	13272-2206	1
VALVE-CHECK (Ref # 16087)	16087-0008	1
BRACKET-TANK (Ref # 32052)	32052-0751	1
TANK-FUEL (Ref # 51004)	51004-0009	1
CAP-TANK,FUEL (Ref # 51049)	51049-0718	1
GAUGE,FUEL (Ref # 52005)	52005-0753	1
O RING,9MM (Ref # 670)	670E1509	1
O RING (Ref # 670A)	670E5090	1
FITTING (Ref # 92005)	92005-0813	1
CLAMP,HOSE CLIP (Ref # 92037)	92037-1181	1
CLAMP,TUBE (Ref # 92037A)	92037-1461	1
BAND (Ref # 92072)	92072-0850	1
COLLAR,6.8X10X18.1 (Ref # 92152)	92152-1867	1
BOLT,6X15.6 (Ref # 92154)	92154-1250	1
BOLT,FUEL PUMP (Ref # 92154A)	92154-1326	1
DAMPER (Ref # 92160)	92160-1075	1
DAMPER,30X56X25 (Ref # 92161)	92161-1613	1
DAMPER,10X28X17 (Ref # 92161A)	92161-1614	1
DAMPER,80X200X3.175 (Ref # 92161B)	92161-1645	1
DAMPER (Ref # 92161C)	92161-1876	1
TUBE,BREATHER (Ref # 92192)	92192-0773	1
TUBE,BREATHER,5X9X220 (Ref # 92192A)	92192-1199	1
TUBE,FUEL,8X13X137 (Ref # 92192B)	92192-1474	1