

2019 PARTS DIAGRAM

Cylinder Head

E1111

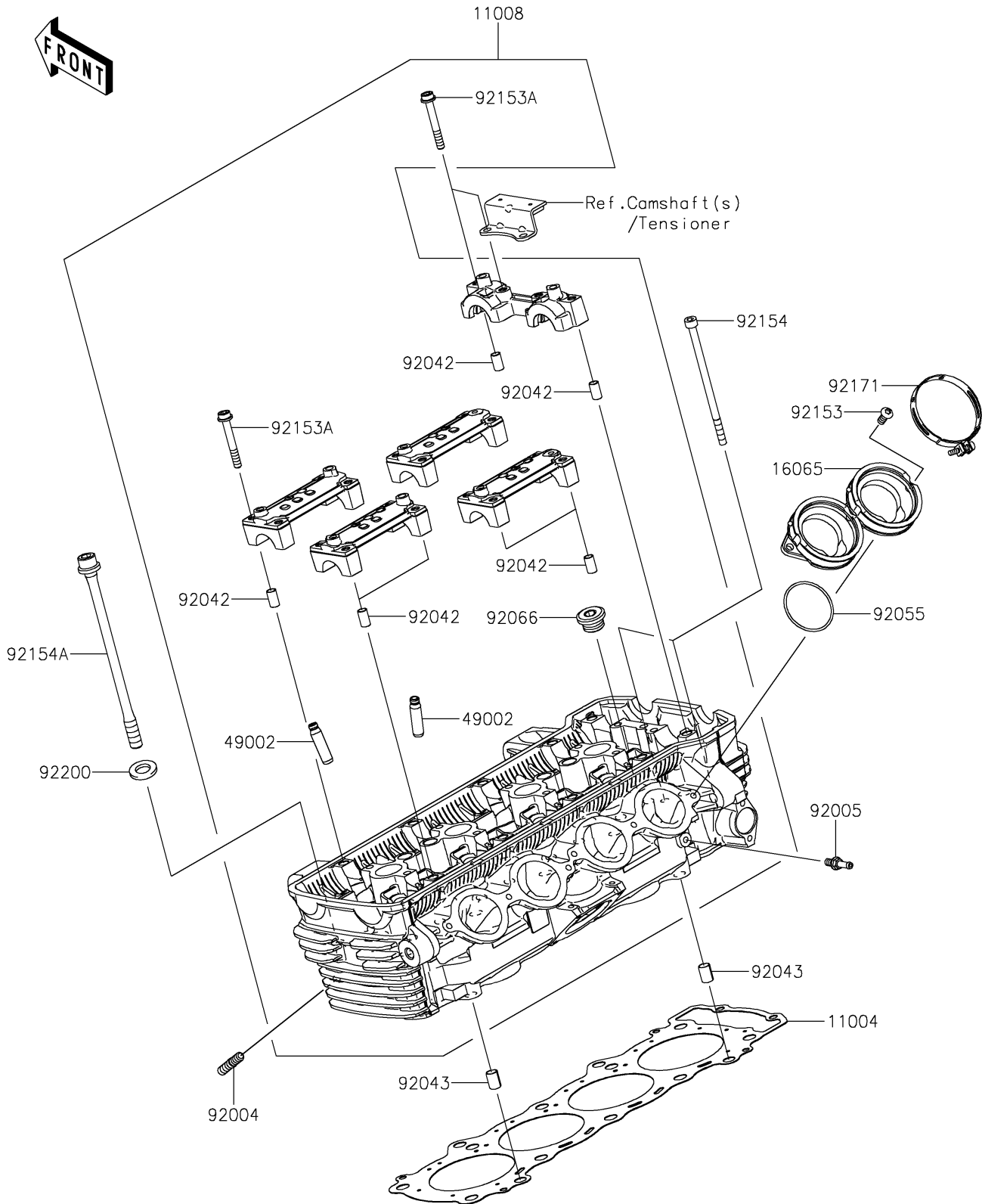

2019 PARTS LIST

Cylinder Head

ITEM NAME	PART NUMBER	QUANTITY
GASKET-HEAD (Ref # 11004)	11004-0769	1
HEAD-COMP-CYLINDER (Ref # 11008)	11008-0932	1
HOLDER-CARBURETOR (Ref # 16065)	16065-0132	1
GUIDE-VALVE (Ref # 49002)	49002-0009	1
STUD (Ref # 92004)	92004-0050	1
FITTING (Ref # 92005)	92005-0826	1
PIN,DOWEL,6.3X8X14 (Ref # 92042)	92042-007	1
PIN,8.2X10X14 (Ref # 92043)	92043-1264	1
RING-O,42X1.9 (Ref # 92055)	92055-1536	1
PLUG,18X10 (Ref # 92066)	92066-0832	1
BOLT,TORX,6X14 (Ref # 92153)	92153-0406	1
BOLT,SOCKET,6X45 (Ref # 92153A)	92153-0656	1
BOLT,SOCKET,6X115 (Ref # 92154)	92154-0205	1
BOLT,FLANGED,10X165 (Ref # 92154A)	92154-2638	1
CLAMP,60MM (Ref # 92171)	92171-0729	1
WASHER,10.2X18.4X1.8 (Ref # 92200)	92200-1691	1