

2019 MULE PRO-MX™ CAMO (EPS) PARTS DIAGRAM

Meter(s)

F2530

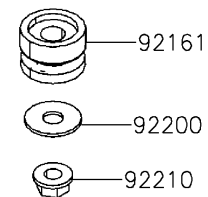
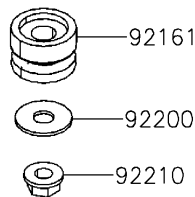
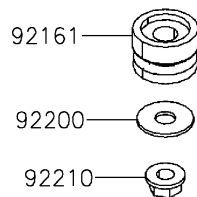
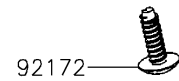
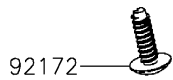
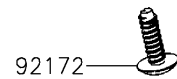
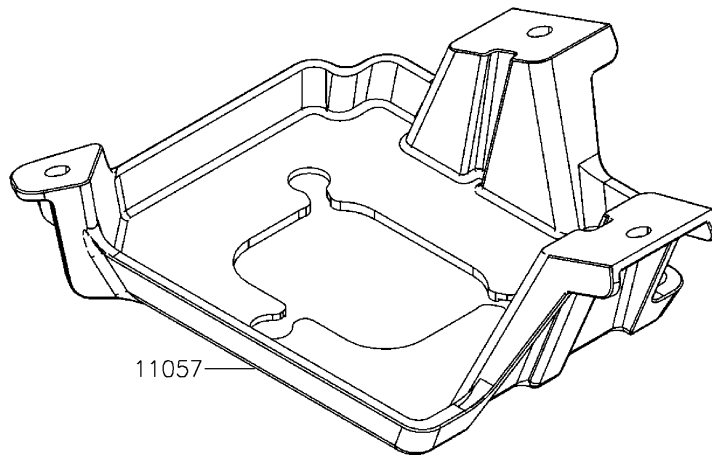
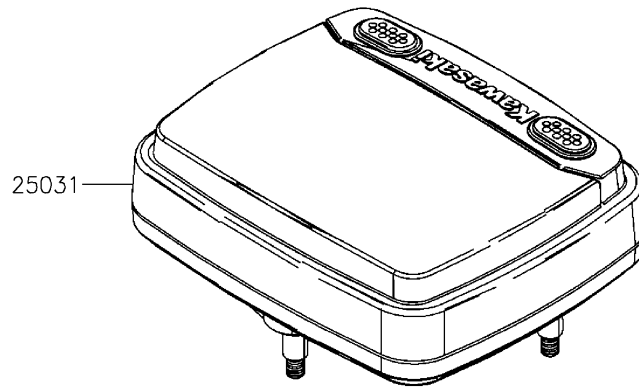

2019 MULE PRO-MX™ CAMO (EPS) PARTS LIST

Meter(s)

| ITEM NAME | PART NUMBER | QUANTITY |
|----------------------------------|-------------|----------|
| BRACKET,METER (Ref # 11057) | 11057-Y005 | 1 |
| METER-ASSY (Ref # 25031) | 25031-Y010 | 1 |
| DAMPER (Ref # 92161) | 92161-Y044 | 1 |
| SCREW,TAPPING,5X16 (Ref # 92172) | 92172-Y020 | 1 |
| WASHER,6X16X1 (Ref # 92200) | 92200-Y094 | 1 |
| NUT,FLANGE,5MM (Ref # 92210) | 92210-Y033 | 1 |