

2016 Vulcan® 1700 Vaquero® ABS PARTS DIAGRAM

Accessory(Pass.Floorboard)

F2910A

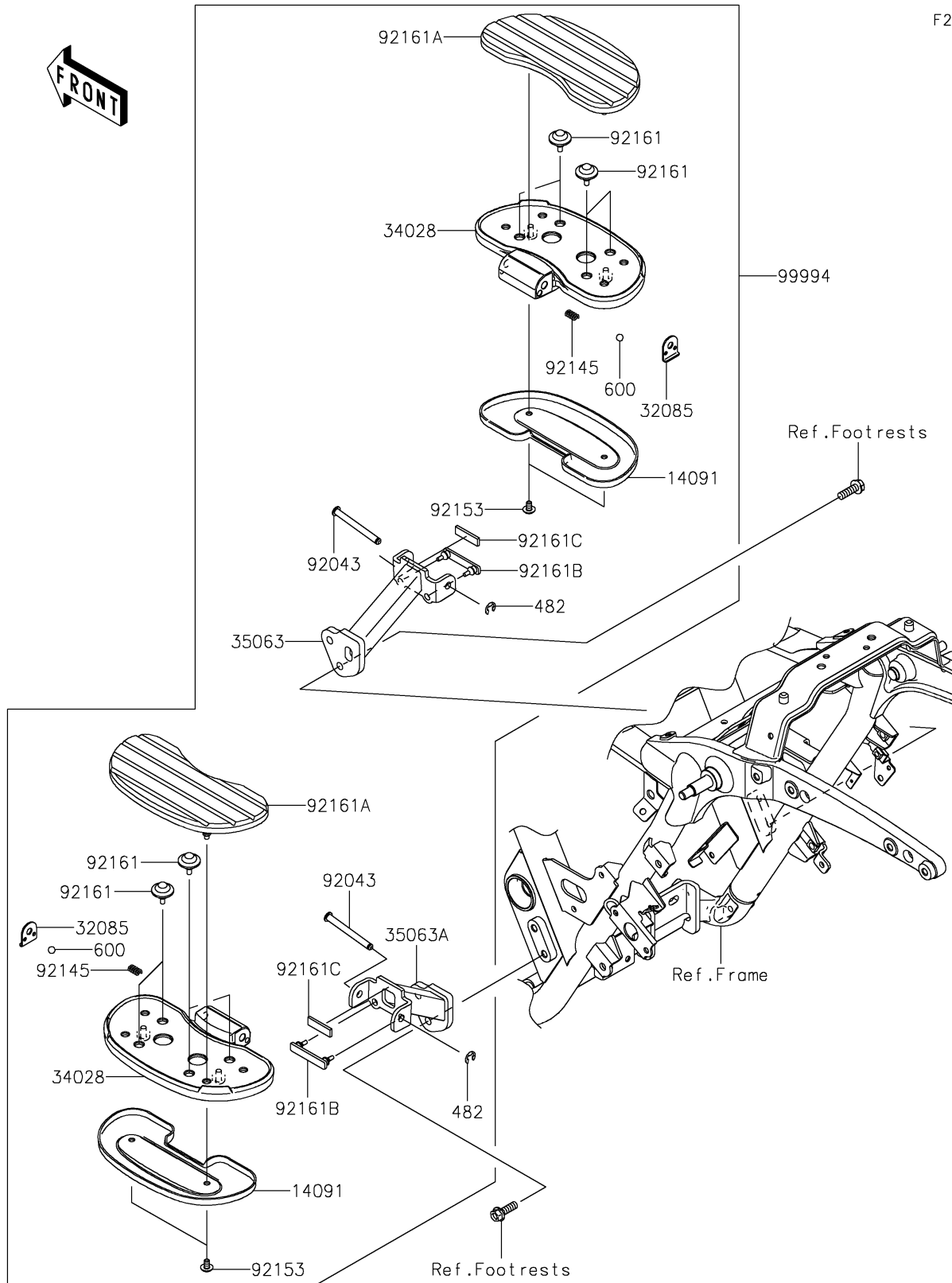

2016 Vulcan® 1700 Vaquero® ABS PARTS LIST

Accessory(Pass.Floorboard)

ITEM NAME	PART NUMBER	QUANTITY
COVER,REAR STEP (Ref # 14091)	14091-1808	1
STOPPER,REAR STEP (Ref # 32085)	32085-0045	1
STEP,RR (Ref # 34028)	34028-0145	1
STAY,RR,RH,F.S.BLACK (Ref # 35063)	35063-0649-18R	1
STAY,RR,LH,F.S.BLACK (Ref # 35063A)	35063-0669-18R	1
CIRCLIP-TYPE-E (Ref # 482)	482EA7000	1
BALL-STEEL,1/4 (Ref # 600)	600A0800	1
PIN,8X76.5 (Ref # 92043)	92043-0054	1
SPRING (Ref # 92145)	92145-1319	1
BOLT,SOCKET,6X10 (Ref # 92153)	92153-1096	1
DAMPER,STEP (Ref # 92161)	92161-0766	1
DAMPER,REAR STEP (Ref # 92161A)	92161-0771	1
DAMPER,REAR STEP (Ref # 92161B)	92161-0772	1
DAMPER,10X35X3 (Ref # 92161C)	92161-0840	1
KIT-ACCESSORY,P. FLOORBOARD (Ref # 99994)	99994-0406	1