

## 2016 Teryx4™ PARTS DIAGRAM

Reflectors(CN)

F2790

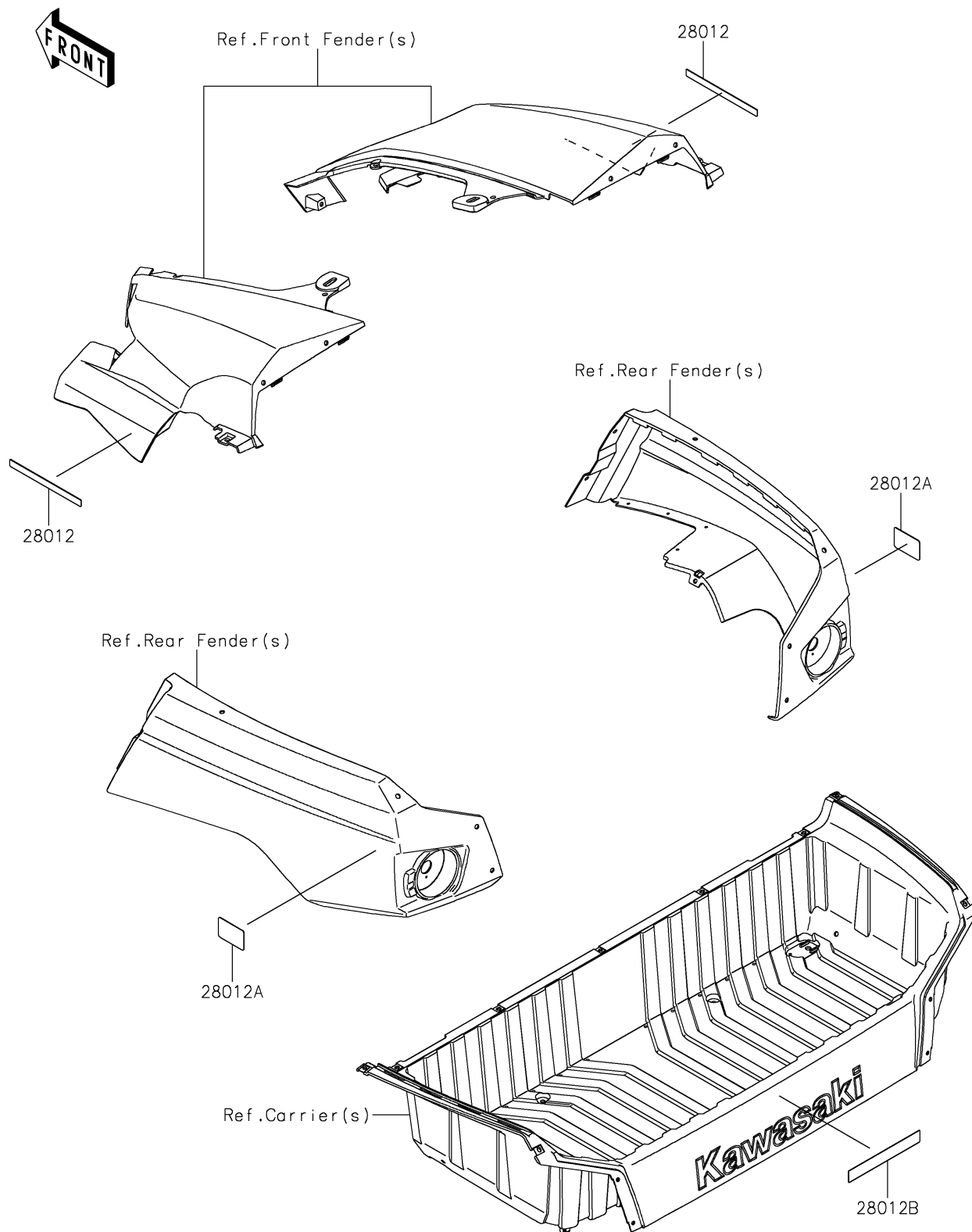

## 2016 Teryx4™ PARTS LIST

Reflectors(CN)

ITEM NAME	PART NUMBER	QUANTITY
REFLECTOR-REFLEX,FR (Ref # 28012)	28012-0014	1
REFLECTOR-REFLEX,REAR,SIDE (Ref # 28012A)	28012-0017	1
REFLECTOR-REFLEX,RR,RED (Ref # 28012B)	28012-0023	1