

2019 KX™100 PARTS DIAGRAM

Rear Master Cylinder

F2293

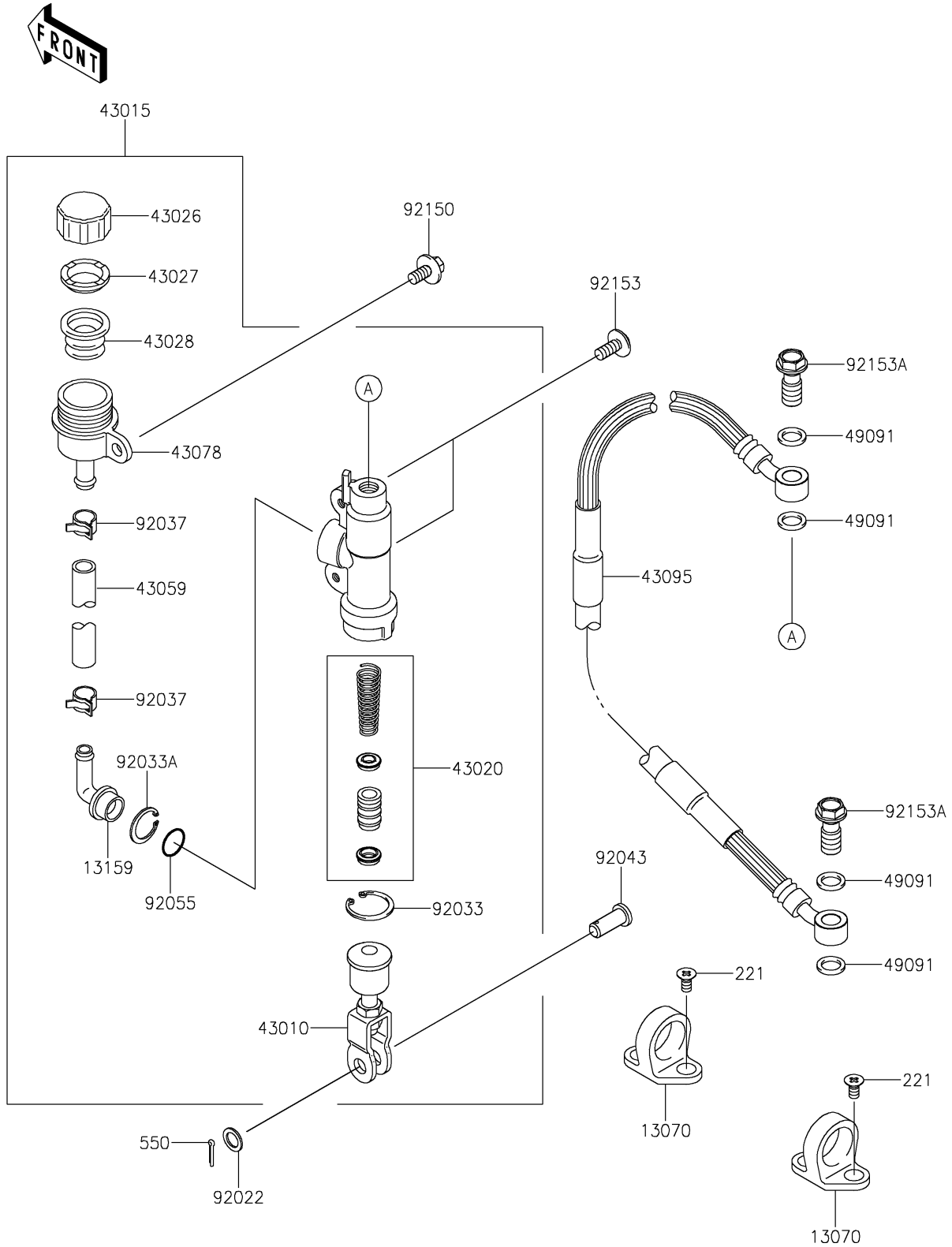

2019 KX™100 PARTS LIST

Rear Master Cylinder

ITEM NAME	PART NUMBER	QUANTITY
GUIDE,HOSE (Ref # 13070)	13070-1381	1
CONNECTOR (Ref # 13159)	13159-1056	1
SCREW-CSK-CROS,5X10 (Ref # 221)	221AA0510	1
ROD-ASSY-BRAKE (Ref # 43010)	43010-1079	1
CYLINDER-ASSY-MASTER,RR (Ref # 43015)	43015-1606	1
PISTON-COMP-BRAKE (Ref # 43020)	43020-1094	1
CAP-BRAKE (Ref # 43026)	43026-1058	1
PLATE-DIAPHRAGM (Ref # 43027)	43027-1052	1
DIAPHRAGM (Ref # 43028)	43028-1060	1
HOSE-BRAKE,RR MASTER CYLINDER (Ref # 43059)	43059-1670	1
RESERVOIR (Ref # 43078)	43078-1068	1
HOSE-BRAKE,RR,L=567 (Ref # 43095)	43095-0668	1
WASHER-SEAL,10.1X14.5X1.5 (Ref # 49091)	49091-0001	1
PIN-COTTER,2.0X15 (Ref # 550)	550AA2015	1
WASHER,8.5X13X1 (Ref # 92022)	92022-1028	1
RING-SNAP,20.9X24.6X1.2 (Ref # 92033)	92033-0079	1
RING-SNAP,20.5MM (Ref # 92033A)	92033-1186	1
CLAMP (Ref # 92037)	92037-1710	1
PIN (Ref # 92043)	92043-0004	1
RING-O,14.8X2.4 (Ref # 92055)	92055-0741	1
BOLT,6X14 (Ref # 92150)	92150-1340	1
BOLT,SOCKET,6X14 (Ref # 92153)	92153-1021	1
BOLT,OIL,L=23 (Ref # 92153A)	92153-1419	1