

2019 KX™100 PARTS DIAGRAM

Engine Mount

F2122

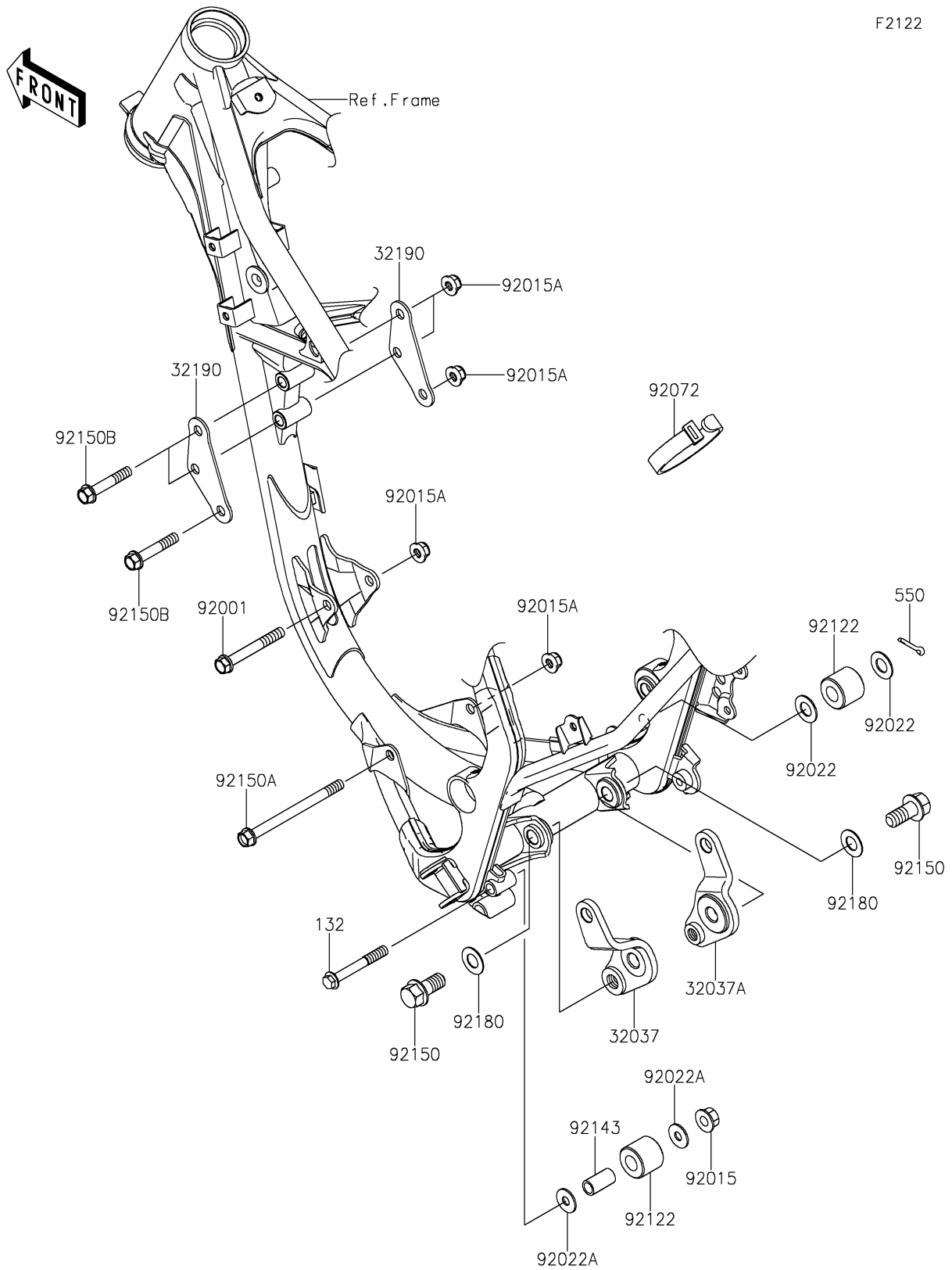

2019 KX™100 PARTS LIST

Engine Mount

ITEM NAME	PART NUMBER	QUANTITY
BOLT-FLANGED-SMALL,8X60 (Ref # 132)	132BA0860	1
BRACKET-SHOCKABSORBER (Ref # 32037)	32037-1552	1
BRACKET-SHOCKABSORBER (Ref # 32037A)	32037-1553	1
BRACKET-ENGINE,HEAD (Ref # 32190)	32190-1119	1
PIN-COTTER,2.5X18 (Ref # 550)	550AA2518	1
BOLT,FLANGED,8X63 (Ref # 92001)	92001-1006	1
NUT,FLANGED,8MM (Ref # 92015)	92015-1406	1
NUT,8MM (Ref # 92015A)	92015-1432	1
WASHER (Ref # 92022)	92022-107	1
WASHER,8.5X20X1.6 (Ref # 92022A)	92022-1561	1
BAND,L=140 (Ref # 92072)	92072-1293	1
ROLLER,CHAIN GUIDE (Ref # 92122)	92122-1213	1
COLLAR,9.5X12.7X25 (Ref # 92143)	92143-1432	1
BOLT,FLANGED,12X27 (Ref # 92150)	92150-1359	1
BOLT,FLANGED,8X105 (Ref # 92150A)	92150-1482	1
BOLT,FLANGED,8X45 (Ref # 92150B)	92150-1487	1
SHIM,12.5X24X0.5 (Ref # 92180)	92180-1060	1