

2019 KX™100 PARTS DIAGRAM

Cylinder Head/Cylinder

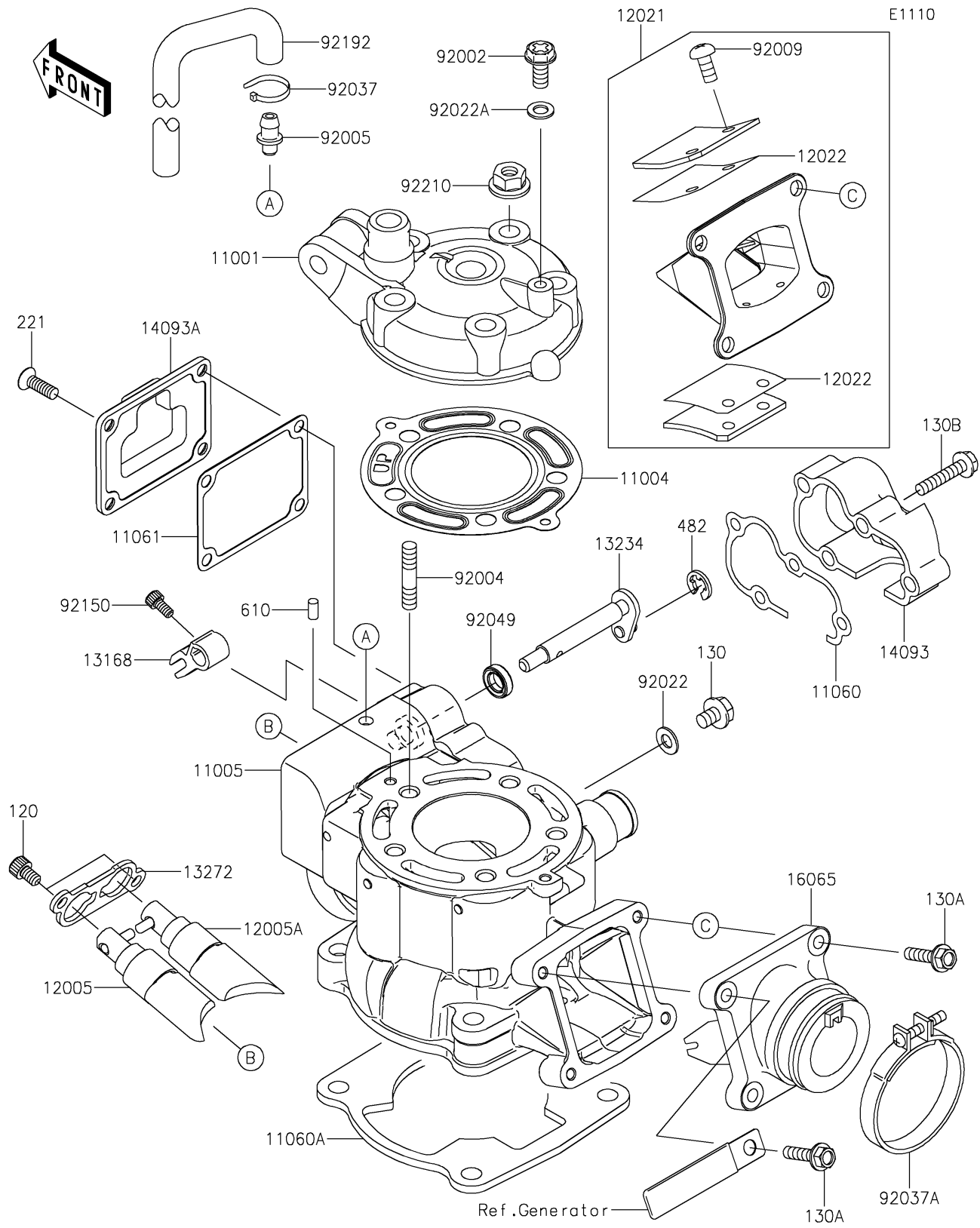

2019 KX™100 PARTS LIST

Cylinder Head/Cylinder

ITEM NAME	PART NUMBER	QUANTITY
HEAD-CYLINDER (Ref # 11001)	11001-0774	1
GASKET-HEAD (Ref # 11004)	11004-0739	1
CYLINDER-ENGINE (Ref # 11005)	11005-0626	1
GASKET,GOVERNOR COVER (Ref # 11060)	11060-1778	1
GASKET,CYLINDER BASE (Ref # 11060A)	11060-1779	1
GASKET (Ref # 11061)	11061-0889	1
BOLT-SOCKET,5X10 (Ref # 120)	120CA0510	1
VALVE-EXHAUST (Ref # 12005)	12005-0731	1
VALVE-EXHAUST (Ref # 12005A)	12005-0733	1
VALVE-ASSY-REED (Ref # 12021)	12021-1123	1
VALVE-REED (Ref # 12022)	12022-1084	1
BOLT-FLANGED,6X8 (Ref # 130)	130AA0608	1
BOLT-FLANGED,5X20 (Ref # 130A)	130BA0520	1
BOLT-FLANGED,5X25 (Ref # 130B)	130BA0525	1
LEVER (Ref # 13168)	13168-0779	1
SHAFT-COMP (Ref # 13234)	13234-0048	1
PLATE (Ref # 13272)	13272-1450	1
COVER (Ref # 14093)	14093-0003	1
COVER (Ref # 14093A)	14093-0046	1
HOLDER-CARBURETOR (Ref # 16065)	16065-1372	1
SCREW-CSK-CROS,5X12 (Ref # 221)	221AA0512	1
CIRCLIP-TYPE-E,5MM (Ref # 482)	482J5000	1
ROLLER,4X8 (Ref # 610)	610A0408	1
BOLT,6X10 (Ref # 92002)	92002-1222	1
STUD,8X33 (Ref # 92004)	92004-1253	1
FITTING (Ref # 92005)	92005-0050	1
SCREW,REED VALVE (Ref # 92009)	92009-1014	1
WASHER,6.1X12X1 (Ref # 92022)	92022-077	1
WASHER,6.2X11X1 (Ref # 92022A)	92022-304	1

2019 KX™100 PARTS LIST

Cylinder Head/Cylinder

ITEM NAME	PART NUMBER	QUANTITY
CLAMP (Ref # 92037)	92037-1173	1
CLAMP (Ref # 92037A)	92037-1843	1
SEAL-OIL,SD088144 (Ref # 92049)	92049-1238	1
BOLT,SOCKET,4X8 (Ref # 92150)	92150-1888	1
TUBE,L=426.3 (Ref # 92192)	92192-0265	1
NUT,8MM (Ref # 92210)	92210-0076	1