

2018 MULE PRO-FX™ EPS LE PARTS DIAGRAM

Wheels/Tires

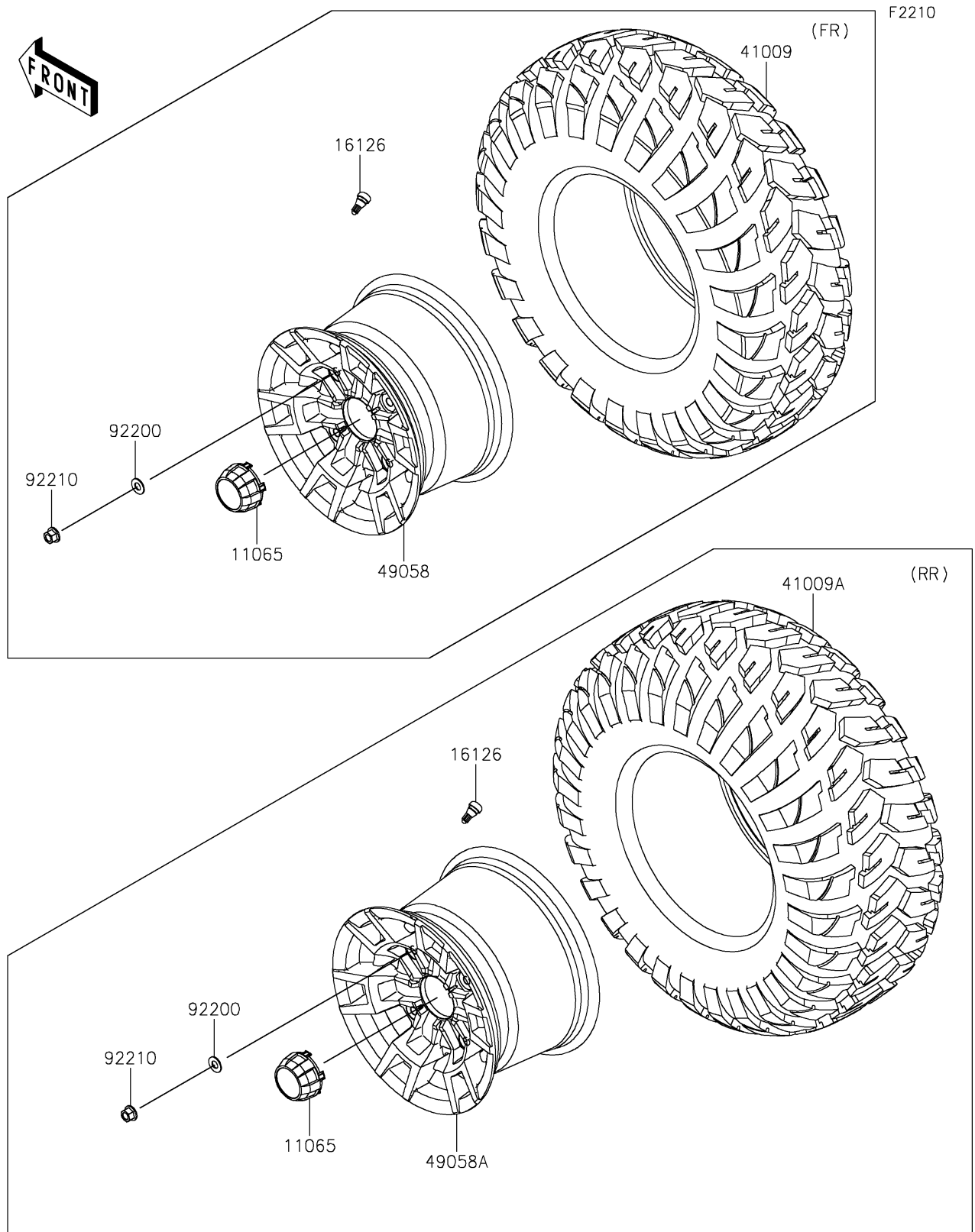

2018 MULE PRO-FX™ EPS LE PARTS LIST

Wheels/Tires

ITEM NAME	PART NUMBER	QUANTITY
CAP,WHEEL,F.BLACK (Ref # 11065)	11065-0893-6Z	1
VALVE (Ref # 16126)	16126-4001	1
TIRE,FR,26X9.00R12 4PR,FRONTIER (Ref # 41009)	41009-0567	1
TIRE,RR,26X11.00R12 4PR,FRONTIER (Ref # 41009A)	41009-0568	1
WHEEL,FR,12X7.0AT,AL,BLACK (Ref # 49058)	49058-0625-31D	1
WHEEL,RR,12X8.0AT,AL,BLACK (Ref # 49058A)	49058-0626-31D	1
WASHER,12.1X25X1.6 (Ref # 92200)	92200-0455	1
NUT,12MM (Ref # 92210)	92210-0603	1