

2018 MULE PRO-FX™ PARTS DIAGRAM

Crankcase

E1411

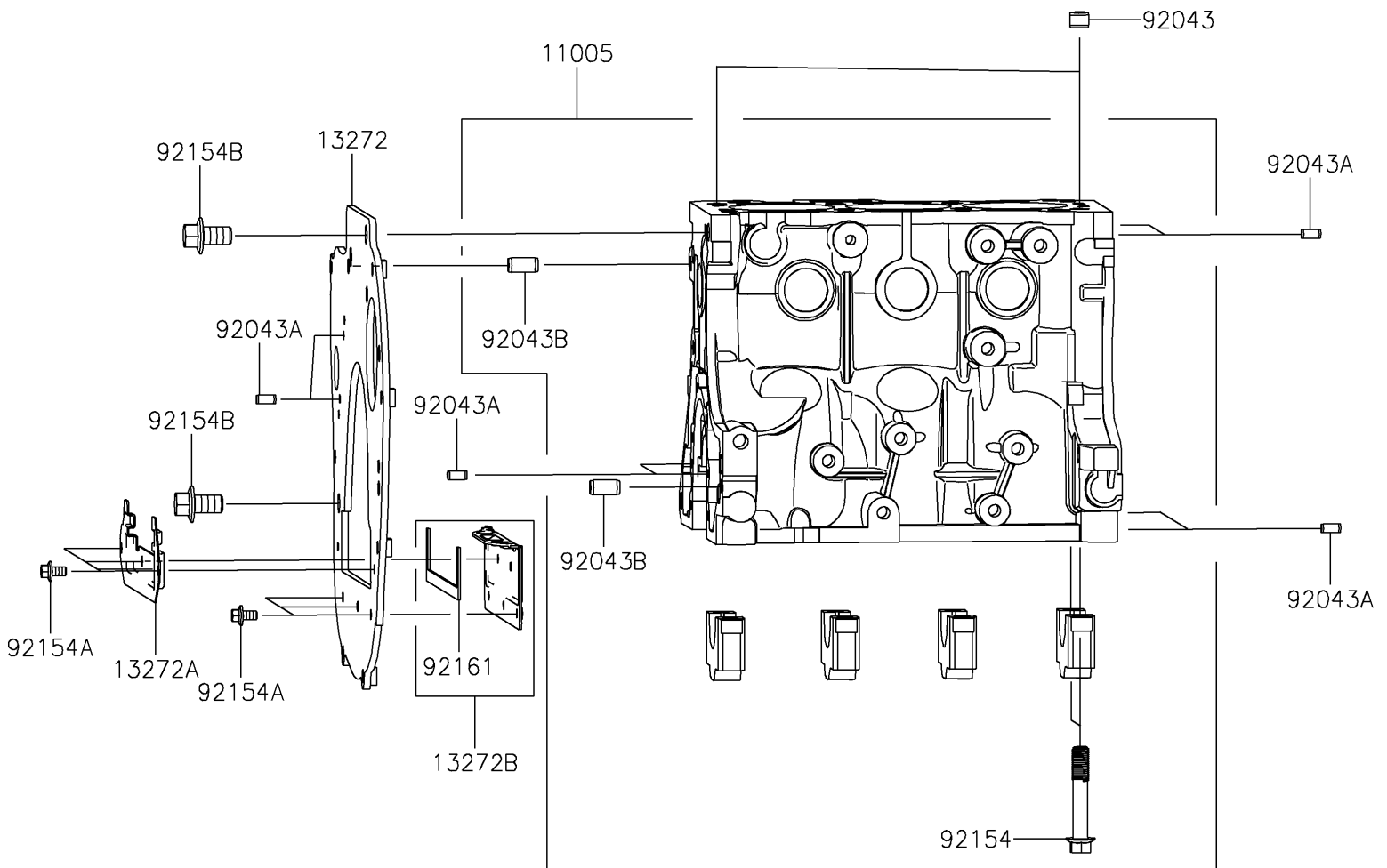

2018 MULE PRO-FX™ PARTS LIST

Crankcase

ITEM NAME	PART NUMBER	QUANTITY
CYLINDER-ENGINE (Ref # 11005)	11005-0654	1
PLATE (Ref # 13272)	13272-1543	1
PLATE (Ref # 13272A)	13272-1858	1
PLATE (Ref # 13272B)	13272-1873	1
PIN (Ref # 92043)	92043-0827	1
PIN (Ref # 92043A)	92043-0828	1
PIN (Ref # 92043B)	92043-0832	1
BOLT,FLANGED (Ref # 92154)	92154-1580	1
BOLT,FLANGED,6X10 (Ref # 92154A)	92154-1581	1
BOLT,FLANGED,12X20 (Ref # 92154B)	92154-1582	1
DAMPER (Ref # 92161)	92161-1605	1