

2018 MULE PRO-FXT™ EPS LE PARTS DIAGRAM

Front Hubs/Brakes

F2230

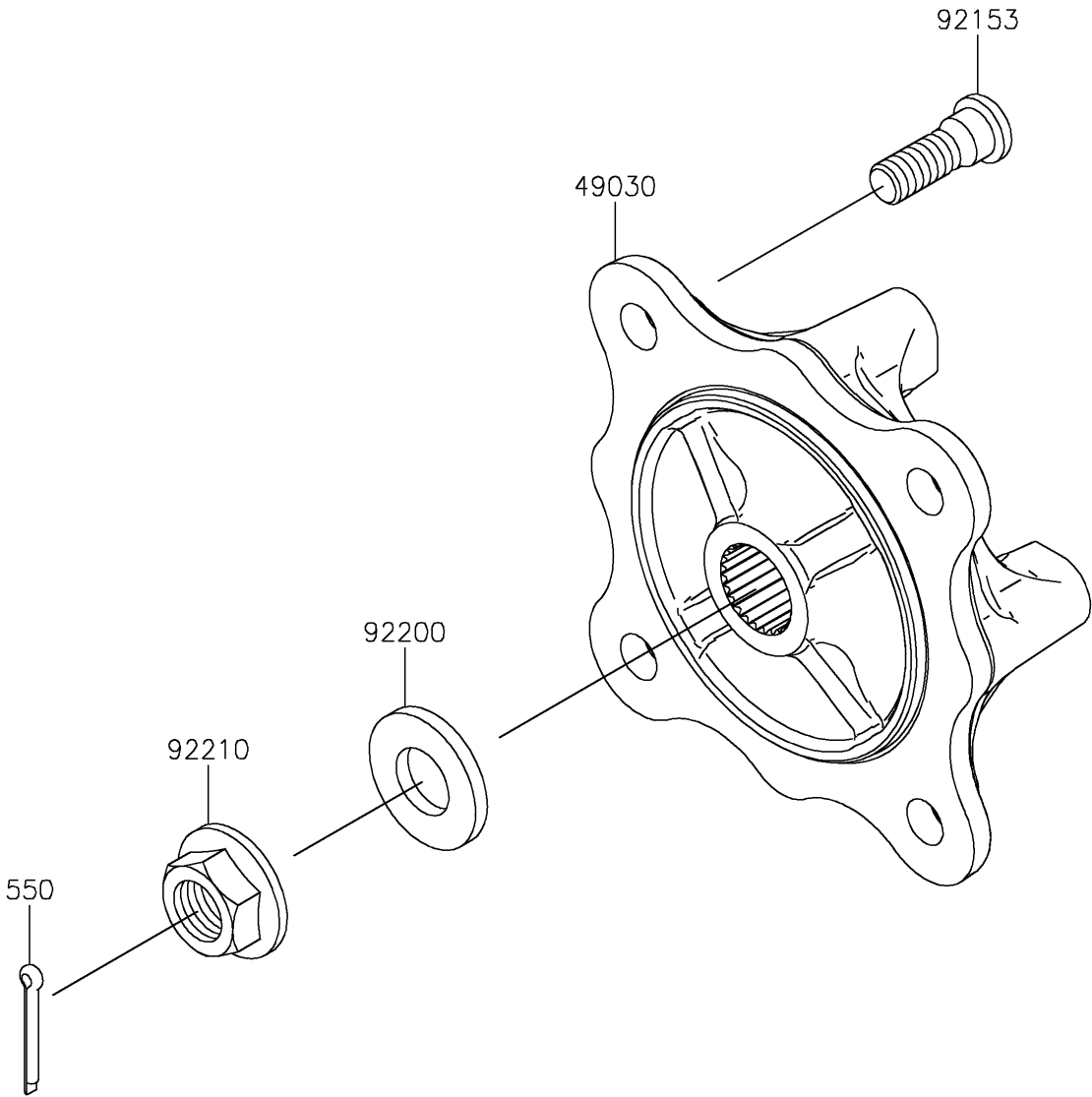

2018 MULE PRO-FXT™ EPS LE PARTS LIST

Front Hubs/Brakes

ITEM NAME	PART NUMBER	QUANTITY
HUB,FR (Ref # 49030)	49030-0048	1
PIN-COTTER,4.0X30 (Ref # 550)	550AA4030	1
BOLT,12MM (Ref # 92153)	92153-1915	1
WASHER,20.3X41X4.5 (Ref # 92200)	92200-0921	1
NUT,FLANGED,20MM (Ref # 92210)	92210-2093	1