

2015 Brute Force® 750 4x4i EPS PARTS DIAGRAM

Crankcase

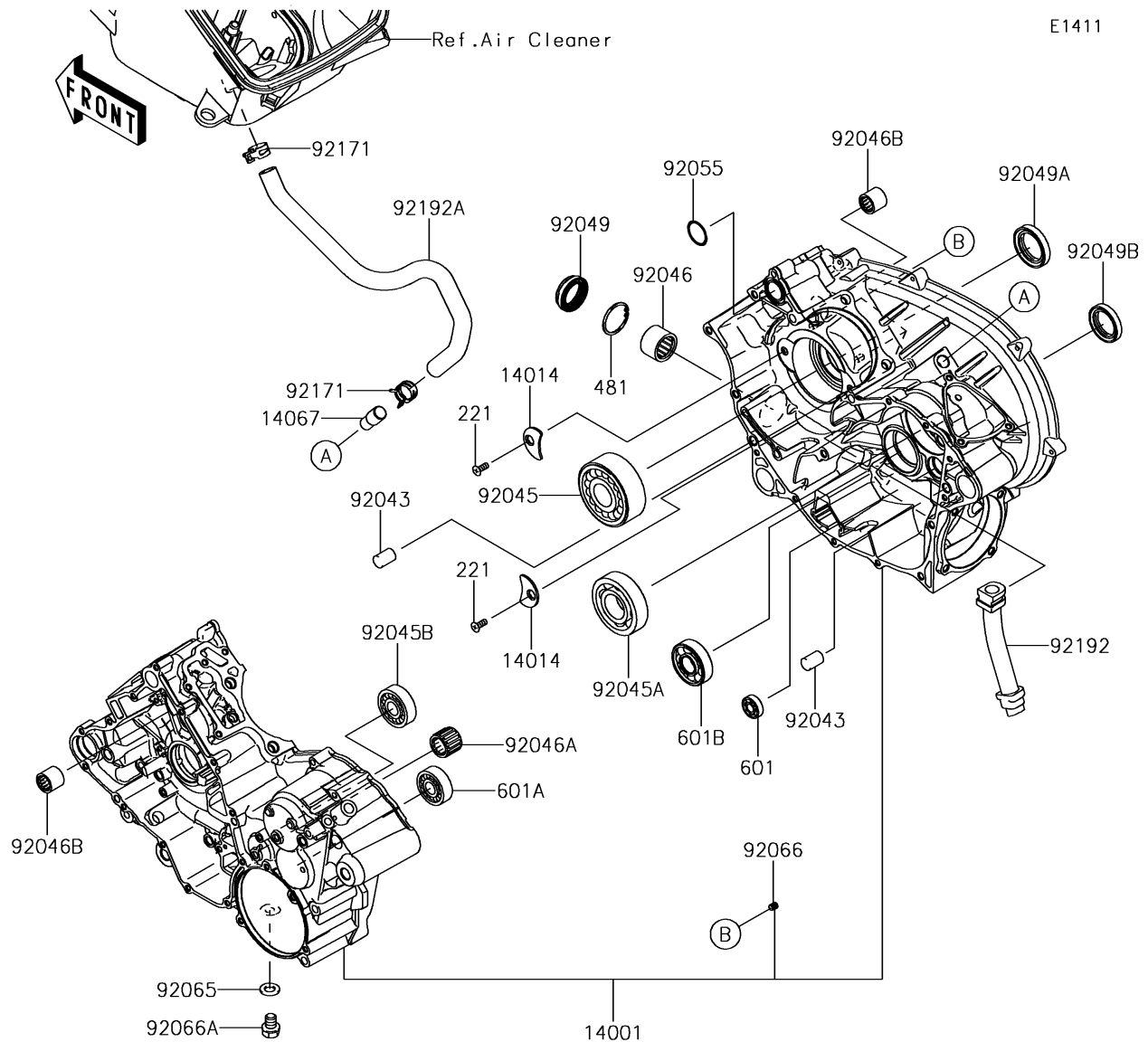

E1411

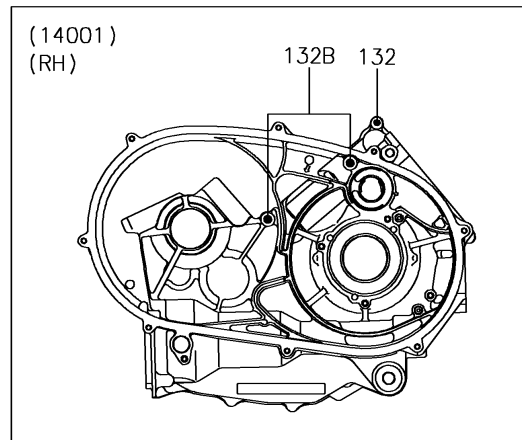
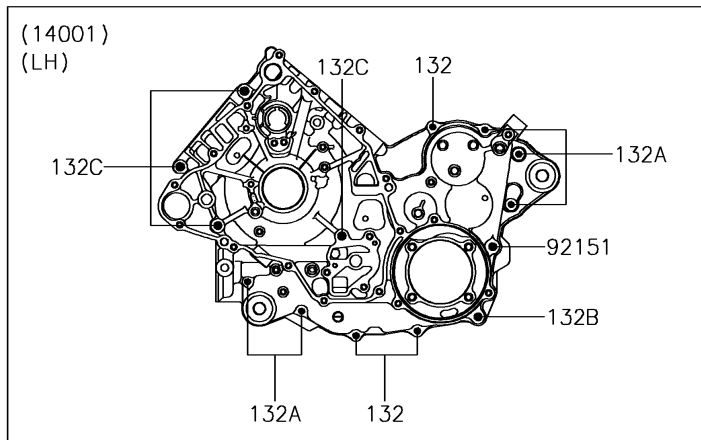

2015 Brute Force® 750 4x4i EPS PARTS LIST

Crankcase

ITEM NAME	PART NUMBER	QUANTITY
BOLT-FLANGED-SMALL,6X40 (Ref # 132)	132BD0640	1
BOLT-FLANGED-SMALL,6X65 (Ref # 132A)	132BD0665	1
BOLT-FLANGED-SMALL,8X110 (Ref # 132B)	132BD08110	1
BOLT-FLANGED-SMALL,8X75 (Ref # 132C)	132BD0875	1
SET-CRANKCASE (Ref # 14001)	14001-0562	1
PLATE-POSITION (Ref # 14014)	14014-0006	1
FITTING,BREATHER (Ref # 14067)	14067-006	1
SCREW-CSK-CROS,6X16 (Ref # 221)	221AA0616	1
CIRCLIP-TYPE-C,37MM (Ref # 481)	481J3700	1
BEARING-BALL (Ref # 601)	601A6000	1
BEARING-BALL,#6004 (Ref # 601A)	601A6004	1
BEARING-BALL,#6304 (Ref # 601B)	601A6304	1
PIN,10X14 (Ref # 92043)	92043-1506	1
BEARING-BALL,5208X2-A-ECG45 (Ref # 92045)	92045-0012	1
BEARING-BALL,6306SH2 (Ref # 92045A)	92045-1190	1
BEARING-BALL,6303LUA (Ref # 92045B)	92045-1389	1
BEARING-NEEDLE (Ref # 92046)	92046-0022	1
BEARING-NEEDLE (Ref # 92046A)	92046-0039	1
BEARING-NEEDLE,TA202715ZE (Ref # 92046B)	92046-1118	1
SEAL-OIL,TC9Y 28X42X8X12 (Ref # 92049)	92049-0755	1
SEAL-OIL,TC 35X50X8 (Ref # 92049A)	92049-1452	1
SEAL-OIL,HTC 30X45X8 (Ref # 92049B)	92049-1575	1
RING-O,25.7X2.4 (Ref # 92055)	92055-1136	1
GASKET,12X22X2 (Ref # 92065)	92065-097	1
PLUG,OIL LINE,7.2X8 (Ref # 92066)	92066-1012	1
PLUG,OIL DRAIN,12X15 (Ref # 92066A)	92066-1174	1
BOLT,8X110 (Ref # 92151)	92151-1689	1
CLAMP (Ref # 92171)	92171-0329	1
TUBE,OIL RETURN (Ref # 92192)	92192-0970	1

2015 Brute Force® 750 4x4i EPS PARTS LIST

Crankcase

ITEM NAME	PART NUMBER	QUANTITY
TUBE,CRANKCASE-A/C (Ref # 92192A)	92192-1157	1