

2018 PARTS DIAGRAM

Cylinder Head

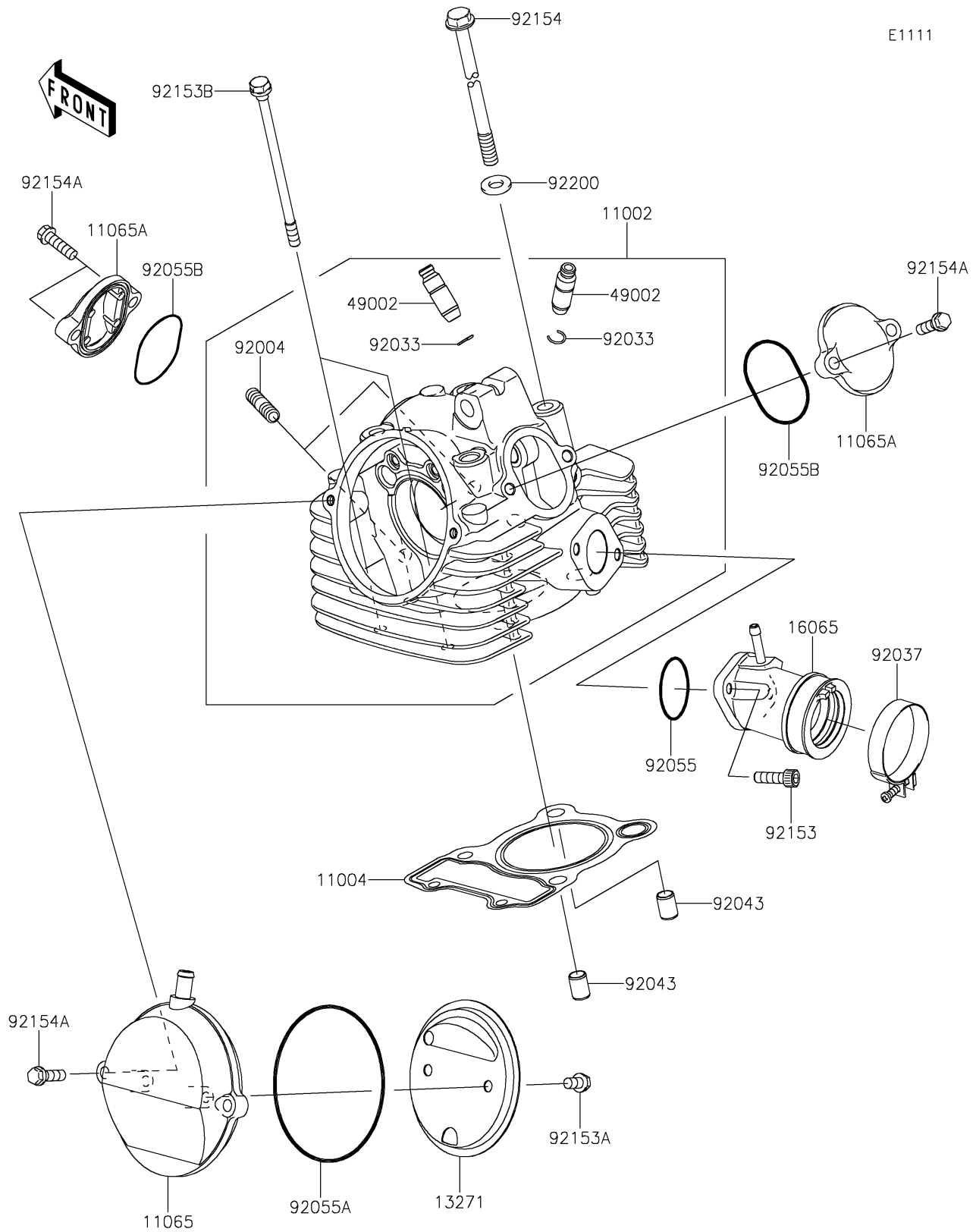

2018 PARTS LIST

Cylinder Head

ITEM NAME	PART NUMBER	QUANTITY
HEAD-ASSY-CYLINDER (Ref # 11002)	11002-0126	1
GASKET-HEAD (Ref # 11004)	11004-0751	1
CAP (Ref # 11065)	11065-0799	1
CAP,VALVE,ADJUSTING (Ref # 11065A)	11065-0800	1
PLATE,BREATHER (Ref # 13271)	13271-1844	1
HOLDER-CARBURETOR (Ref # 16065)	16065-0061	1
GUIDE-VALVE (Ref # 49002)	49002-0019	1
STUD,8X22 (Ref # 92004)	92004-0722	1
RING-SNAP (Ref # 92033)	92033-0789	1
CLAMP (Ref # 92037)	92037-1305	1
PIN,8.2X10X14 (Ref # 92043)	92043-0100	1
RING-O,32X1.9 (Ref # 92055)	92055-0191	1
RING-O,86X1.9 (Ref # 92055A)	92055-0202	1
RING-O (Ref # 92055B)	92055-1697	1
BOLT,6X20 (Ref # 92153)	92153-0481	1
BOLT,6X10 (Ref # 92153A)	92153-1140	1
BOLT,FLANGED,6X110 (Ref # 92153B)	92153-1970	1
BOLT,FLANGED,8X201 (Ref # 92154)	92154-1155	1
BOLT,FLANGED,6X20 (Ref # 92154A)	92154-1219	1
WASHER,8.2X17X2.3 (Ref # 92200)	92200-1631	1