

2016 NINJA® 300 PARTS DIAGRAM

Seat

F2510

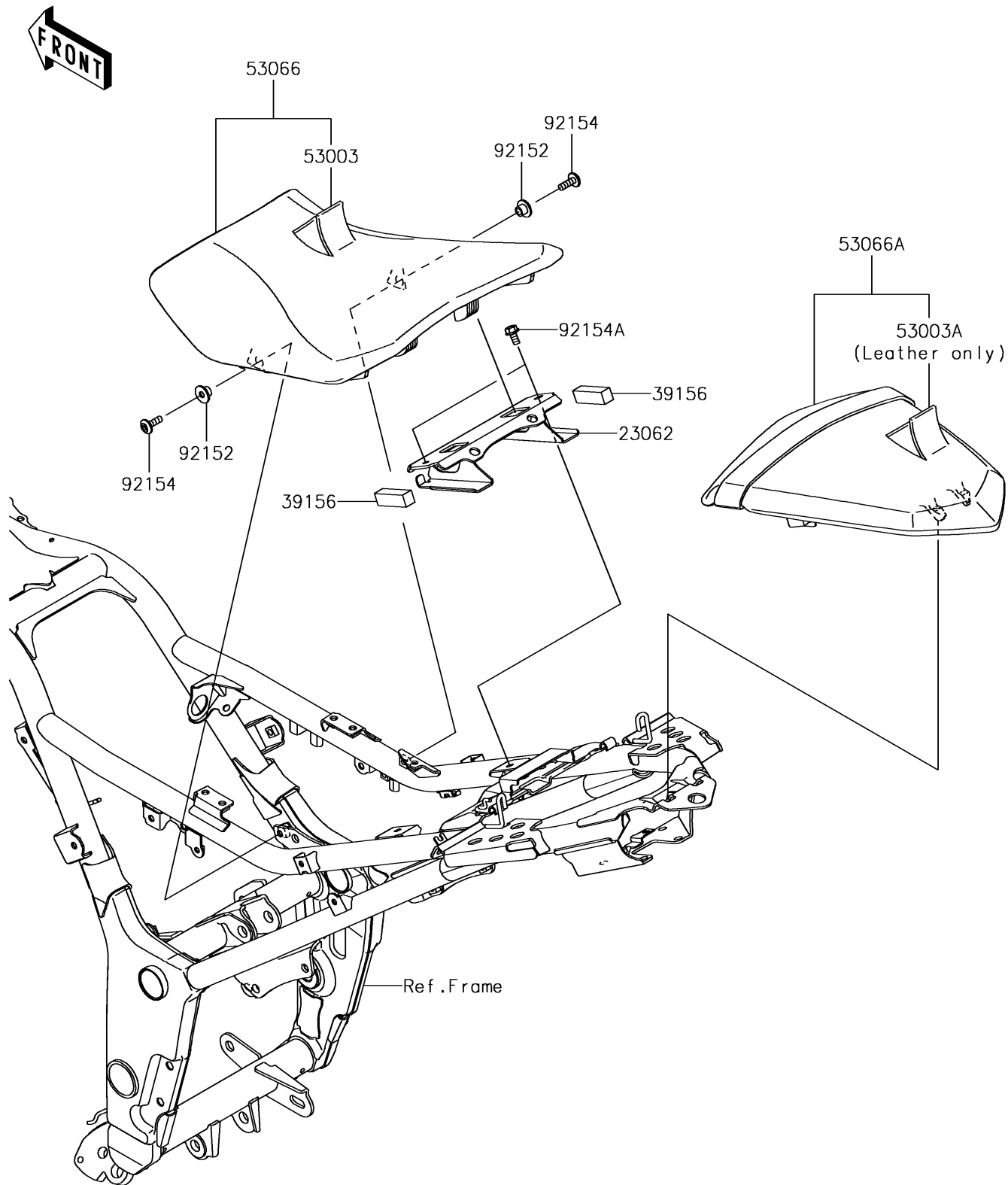

2016 NINJA® 300 PARTS LIST

Seat

| ITEM NAME | PART NUMBER | QUANTITY |
|---|----------------|----------|
| BRACKET-COMP,SEAT (Ref # 23062) | 23062-0782 | 1 |
| PAD,13X43X12 (Ref # 39156) | 39156-0978 | 1 |
| LEATHER,FR,BLACK (Ref # 53003) | 53003-0326-MA | 1 |
| LEATHER,RR,BLACK (Ref # 53003A) | 53003-0327-MA | 1 |
| SEAT-ASSY,FR,BLACK (Ref # 53066) | 53066-0392-MA | 1 |
| SEAT,RR,LEATHER BLK+BAND BLK (Ref # 53066A) | 53066-0393-12Y | 1 |
| COLLAR (Ref # 92152) | 92152-0295 | 1 |
| BOLT,SOCKET,6X18 (Ref # 92154) | 92154-1026 | 1 |
| BOLT,FLANGED,6X12 (Ref # 92154A) | 92154-1050 | 1 |