

2018 NINJA® ZX™-6R PARTS DIAGRAM

Frame Fittings

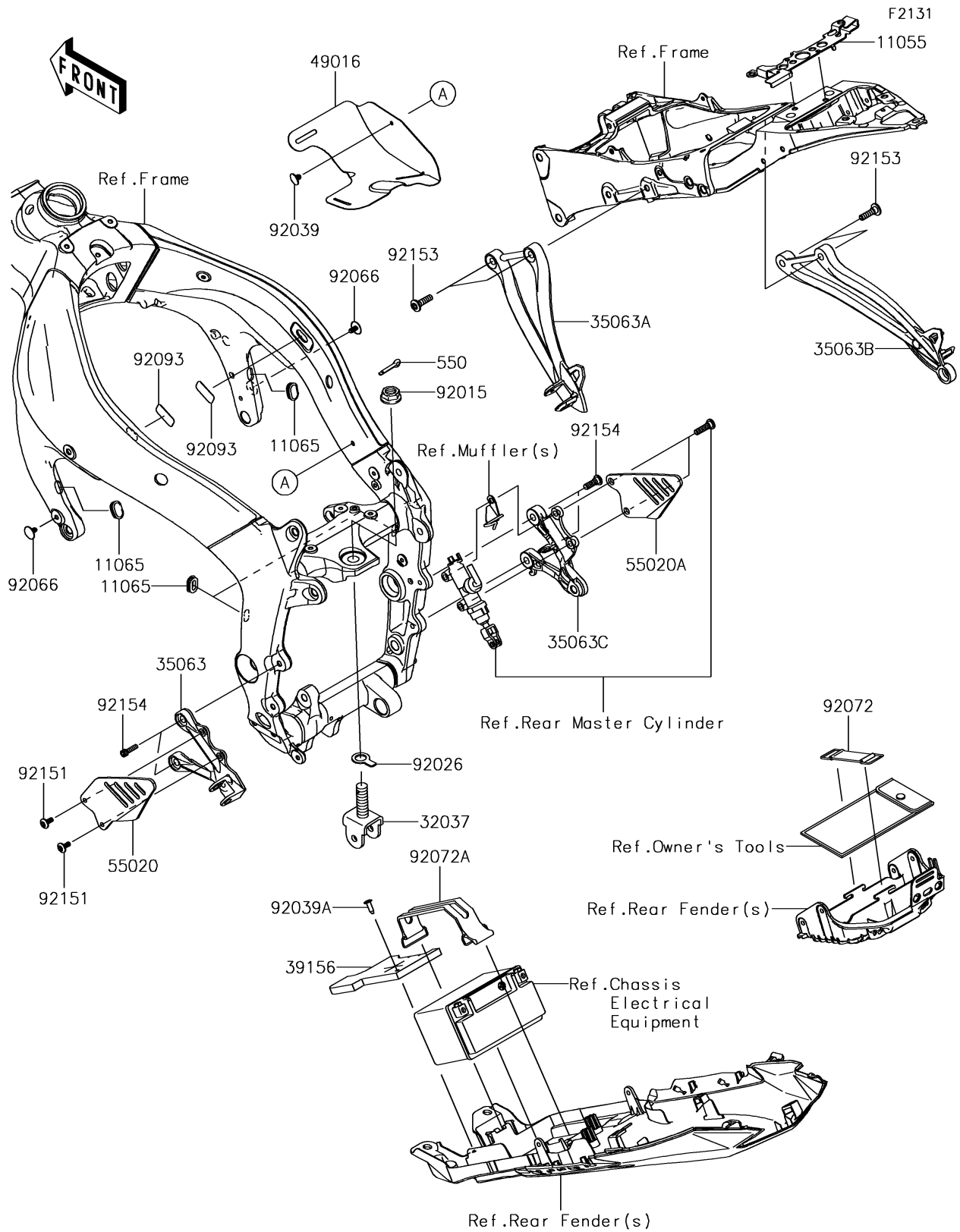

2018 NINJA® ZX™-6R PARTS LIST

Frame Fittings

ITEM NAME	PART NUMBER	QUANTITY
BRACKET,HELMET HOLDER (Ref # 11055)	11055-1011	1
CAP (Ref # 11065)	11065-0095	1
BRACKET-SHOCKABSORBER (Ref # 32037)	32037-1887	1
STAY,FR,LH,F.S.BLACK (Ref # 35063)	35063-0160-18R	1
STAY,RR,LH,F.S.BLACK (Ref # 35063A)	35063-0444-18R	1
STAY,RR,RH,F.S.BLACK (Ref # 35063B)	35063-0445-18R	1
STAY,FR,RH,F.S.BLACK (Ref # 35063C)	35063-0590-18R	1
PAD (Ref # 39156)	39156-1000	1
COVER-SEAL (Ref # 49016)	49016-0595	1
PIN-COTTER,3X25 (Ref # 550)	550S3025	1
GUARD,HEEL,LH (Ref # 55020)	55020-0859	1
GUARD,HEEL,RH (Ref # 55020A)	55020-0860	1
NUT,FLANGED,16MM (Ref # 92015)	92015-1881	1
SPACER,16.5X26X2 (Ref # 92026)	92026-0747	1
RIVET (Ref # 92039)	92039-0065	1
RIVET (Ref # 92039A)	92039-0068	1
PLUG,6X17 (Ref # 92066)	92066-0751	1
BAND (Ref # 92072)	92072-012	1
BAND,L=168 (Ref # 92072A)	92072-1306	1
SEAL (Ref # 92093)	92093-0154	1
BOLT,SOCKET,6X14 (Ref # 92151)	92151-1654	1
BOLT,SOCKET,8X30 (Ref # 92153)	92153-1630	1
BOLT,SOCKET,8X25 (Ref # 92154)	92154-1149	1