

2018 PARTS DIAGRAM

Cylinder Head Cover

E1112

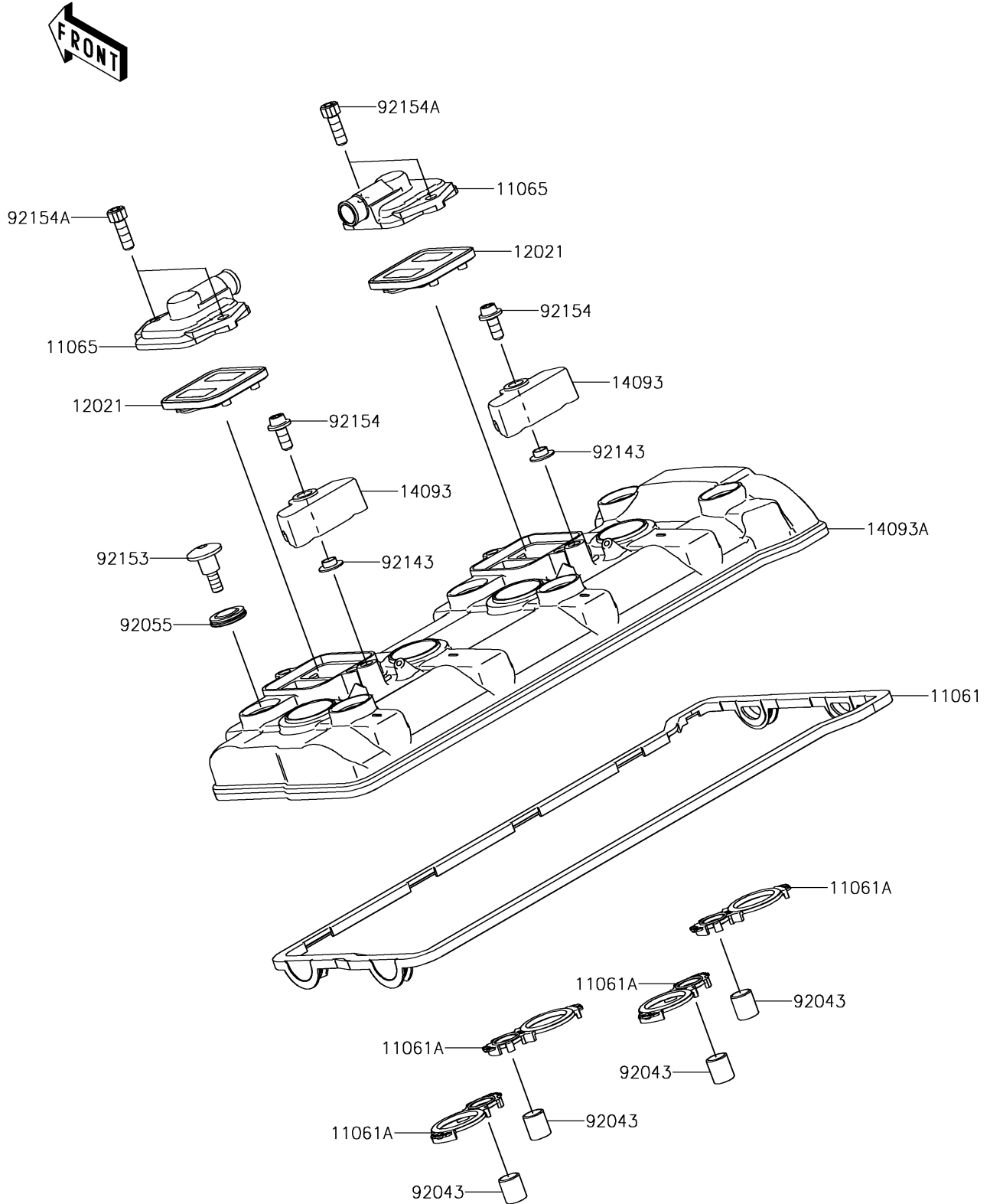

2018 PARTS LIST

Cylinder Head Cover

ITEM NAME	PART NUMBER	QUANTITY
GASKET,HEAD COVER (Ref # 11061)	11061-0436	1
GASKET,PLUG HOLE (Ref # 11061A)	11061-0437	1
CAP (Ref # 11065)	11065-0360	1
VALVE-ASSY-REED (Ref # 12021)	12021-0021	1
COVER (Ref # 14093)	14093-0291	1
COVER,HEAD (Ref # 14093A)	14093-0335	1
PIN,10.1X12X14 (Ref # 92043)	92043-4009	1
RING-O (Ref # 92055)	92055-0187	1
COLLAR (Ref # 92143)	92143-1331	1
BOLT,SOCKET,6X22.5 (Ref # 92153)	92153-1779	1
BOLT,SOCKET,6X14 (Ref # 92154)	92154-1460	1
BOLT,SOCKET,6X18 (Ref # 92154A)	92154-1832	1