

2015 VERSYS® 1000 ABS PARTS DIAGRAM

Rear Fender(s)

F2172

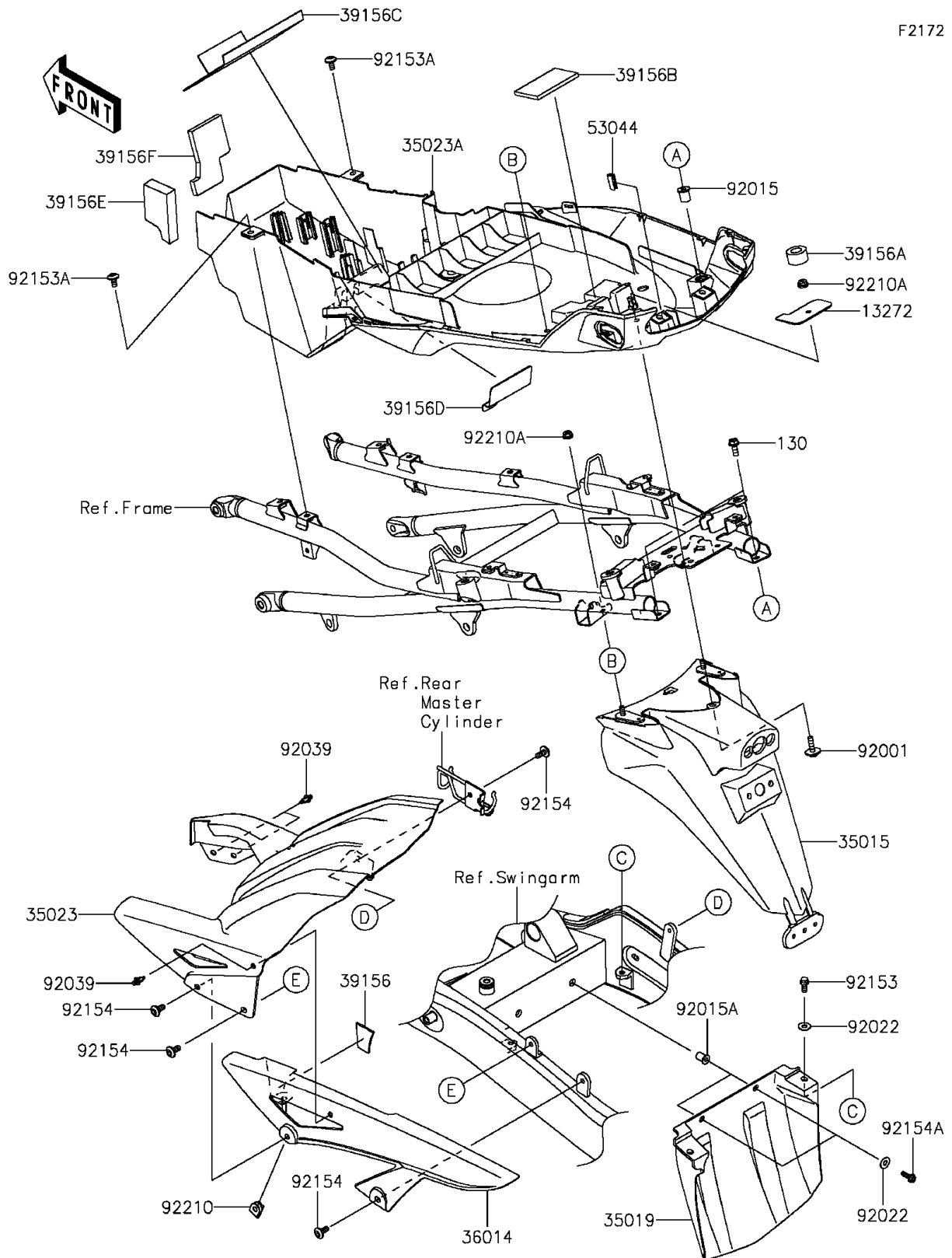

2015 VERSYS® 1000 ABS PARTS LIST

Rear Fender(s)

ITEM NAME	PART NUMBER	QUANTITY
BOLT-FLANGED,6X18 (Ref # 130)	130CA0618	1
PLATE,FLAP (Ref # 13272)	13272-1953	1
FLAP-COMP (Ref # 35015)	35015-0015	1
FLAP,RR (Ref # 35019)	35019-0563	1
FENDER-REAR,INNER (Ref # 35023)	35023-0336	1
FENDER-REAR (Ref # 35023A)	35023-0405	1
CASE-CHAIN (Ref # 36014)	36014-0557	1
PAD,CHAIN CASE (Ref # 39156)	39156-0816	1
PAD,14X33X15 (Ref # 39156A)	39156-0865	1
PAD,45X75X5 (Ref # 39156B)	39156-0866	1
PAD,BATTERY (Ref # 39156C)	39156-0893	1
PAD,60X76X1 (Ref # 39156D)	39156-1863	1
PAD,82X45X15 (Ref # 39156E)	39156-1864	1
PAD,72X85X8 (Ref # 39156F)	39156-1865	1
TRIM,9X20 (Ref # 53044)	53044-0596	1
BOLT,UPSET-WP,6X22 (Ref # 92001)	92001-1774	1
NUT (Ref # 92015)	92015-1700	1
NUT,WELL,5MM (Ref # 92015A)	92015-1757	1
WASHER,6.5X16X1.0 (Ref # 92022)	92022-1093	1
RIVET (Ref # 92039)	92039-0060	1
BOLT (Ref # 92153)	92153-1805	1
BOLT,SOCKET,6X12 (Ref # 92153A)	92153-1948	1
BOLT,SOCKET,6X14 (Ref # 92154)	92154-0745	1
BOLT,FLANGED,5X16 (Ref # 92154A)	92154-1004	1
NUT,6MM (Ref # 92210)	92210-0277	1
NUT,LOCK,FLANGED,6MM (Ref # 92210A)	92210-0303	1