

2017 KX™450F PARTS DIAGRAM

Radiator

E3032

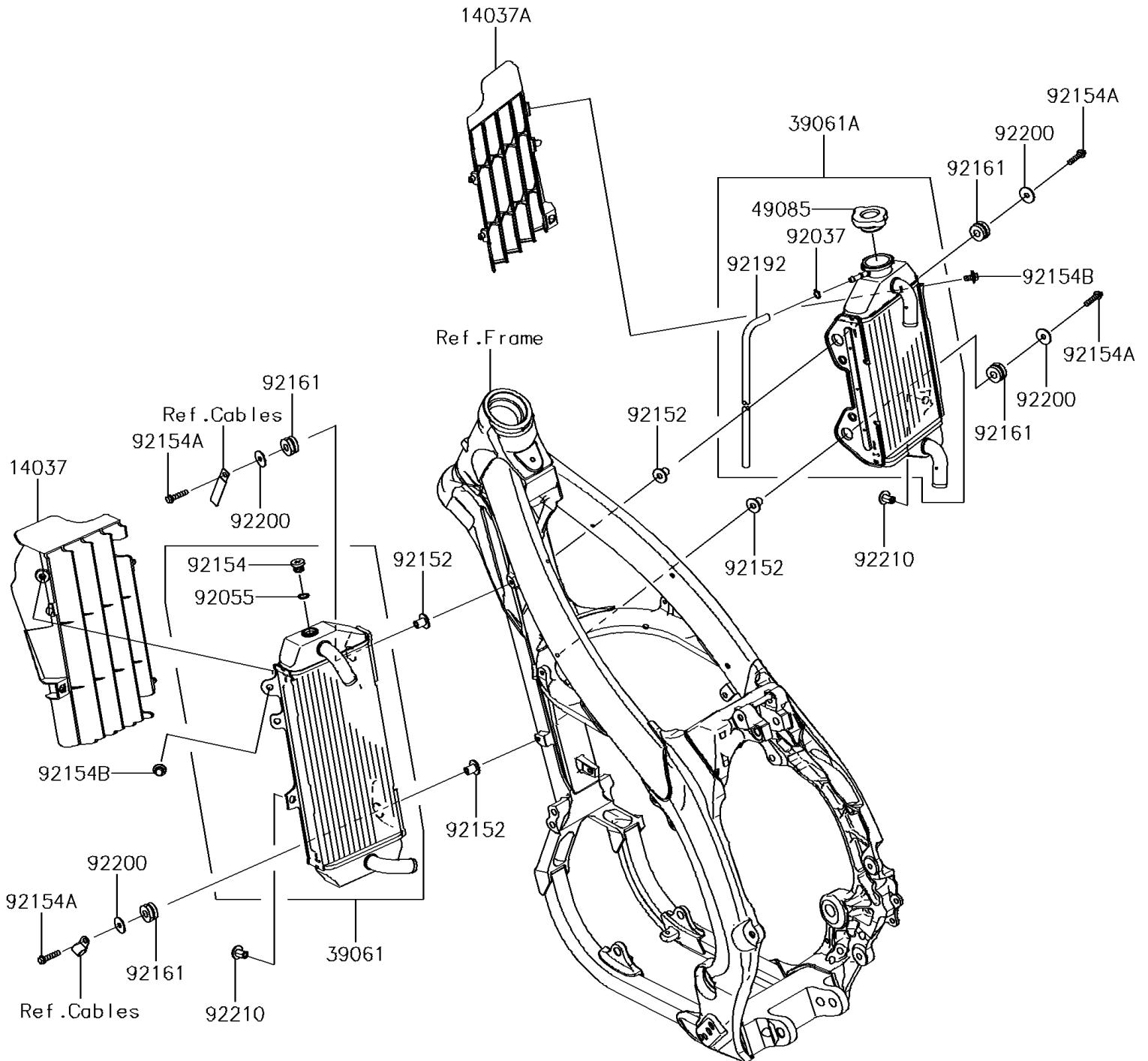

2017 KX™450F PARTS LIST

Radiator

ITEM NAME	PART NUMBER	QUANTITY
SCREEN,LH,EBONY (Ref # 14037)	14037-0767-6C	1
SCREEN,RH,EBONY (Ref # 14037A)	14037-0768-6C	1
RADIATOR-ASSY,LH (Ref # 39061)	39061-0709	1
RADIATOR-ASSY,RH (Ref # 39061A)	39061-0710	1
CAP-ASSY-PRESSURE (Ref # 49085)	49085-0006	1
CLAMP (Ref # 92037)	92037-1610	1
RING-O (Ref # 92055)	92055-0866	1
COLLAR (Ref # 92152)	92152-0666	1
BOLT,AIR VENT (Ref # 92154)	92154-1738	1
BOLT,FLANGED,6X25 (Ref # 92154A)	92154-1928	1
BOLT,FLANGED,6X12 (Ref # 92154B)	92154-1931	1
DAMPER (Ref # 92161)	92161-1781	1
TUBE,L=830 (Ref # 92192)	92192-1490	1
WASHER,6.5X22X1.2 (Ref # 92200)	92200-2108	1
NUT (Ref # 92210)	92210-1452	1