

2013 Vulcan® 1700 Voyager® ABS PARTS DIAGRAM

Front Master Cylinder

F2291

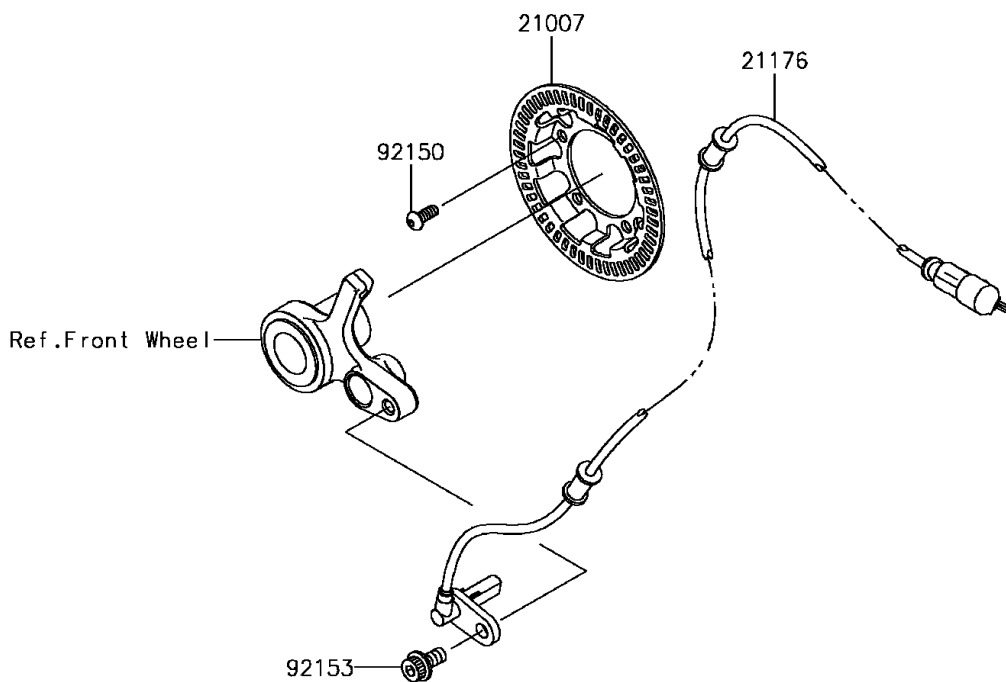
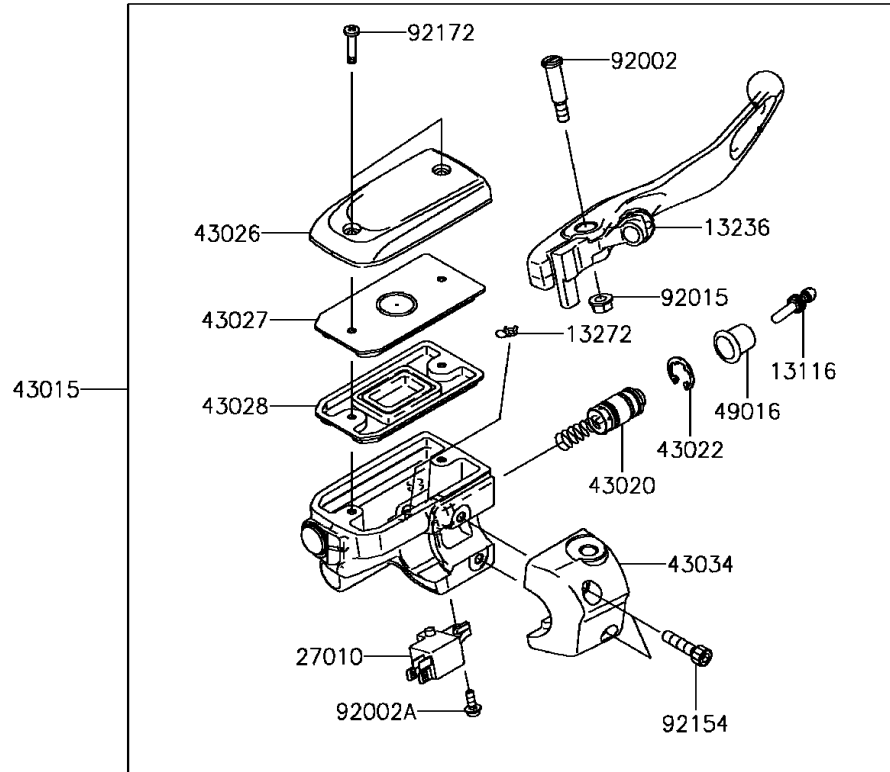

2013 Vulcan® 1700 Voyager® ABS PARTS LIST

Front Master Cylinder

ITEM NAME	PART NUMBER	QUANTITY
ROD-PUSH (Ref # 13116)	13116-0039	1
LEVER-COMP,FRONT BRAKE (Ref # 13236)	13236-0166	1
PLATE (Ref # 13272)	13272-0573	1
ROTOR,SPEED SENSOR (Ref # 21007)	21007-0115	1
SENSOR,FR,SPEED (Ref # 21176)	21176-0138	1
SWITCH,CRUISE CONTROL CANCEL (Ref # 27010)	27010-1232	1
CYLINDER-ASSY-MASTER,FR (Ref # 43015)	43015-0566	1
PISTON-COMP-BRAKE (Ref # 43020)	43020-0014	1
STOPPER-BRAKE,PISTON (Ref # 43022)	43022-1010	1
CAP-BRAKE (Ref # 43026)	43026-0053	1
PLATE-DIAPHRAGM (Ref # 43027)	43027-0004	1
DIAPHRAGM (Ref # 43028)	43028-0010	1
HOLDER-BRAKE,MASTER CYLINDER (Ref # 43034)	43034-0041	1
COVER-SEAL,MASTER CYLINDER (Ref # 49016)	49016-1044	1
BOLT,LEVER SET,BLACK (Ref # 92002)	92002-1322	1
BOLT,SCREW,4X12 (Ref # 92002A)	92002-1323	1
NUT,FLANGED,6MM (Ref # 92015)	92015-1528	1
BOLT,SOCKET,6X14 (Ref # 92150)	92150-1836	1
BOLT,SOCKET,8X16 (Ref # 92153)	92153-0327	1
BOLT,SOCKET (Ref # 92154)	92154-0167	1
SCREW,4MM (Ref # 92172)	92172-0385	1