

2013 Vulcan® 1700 Voyager® ABS PARTS DIAGRAM

Battery Case

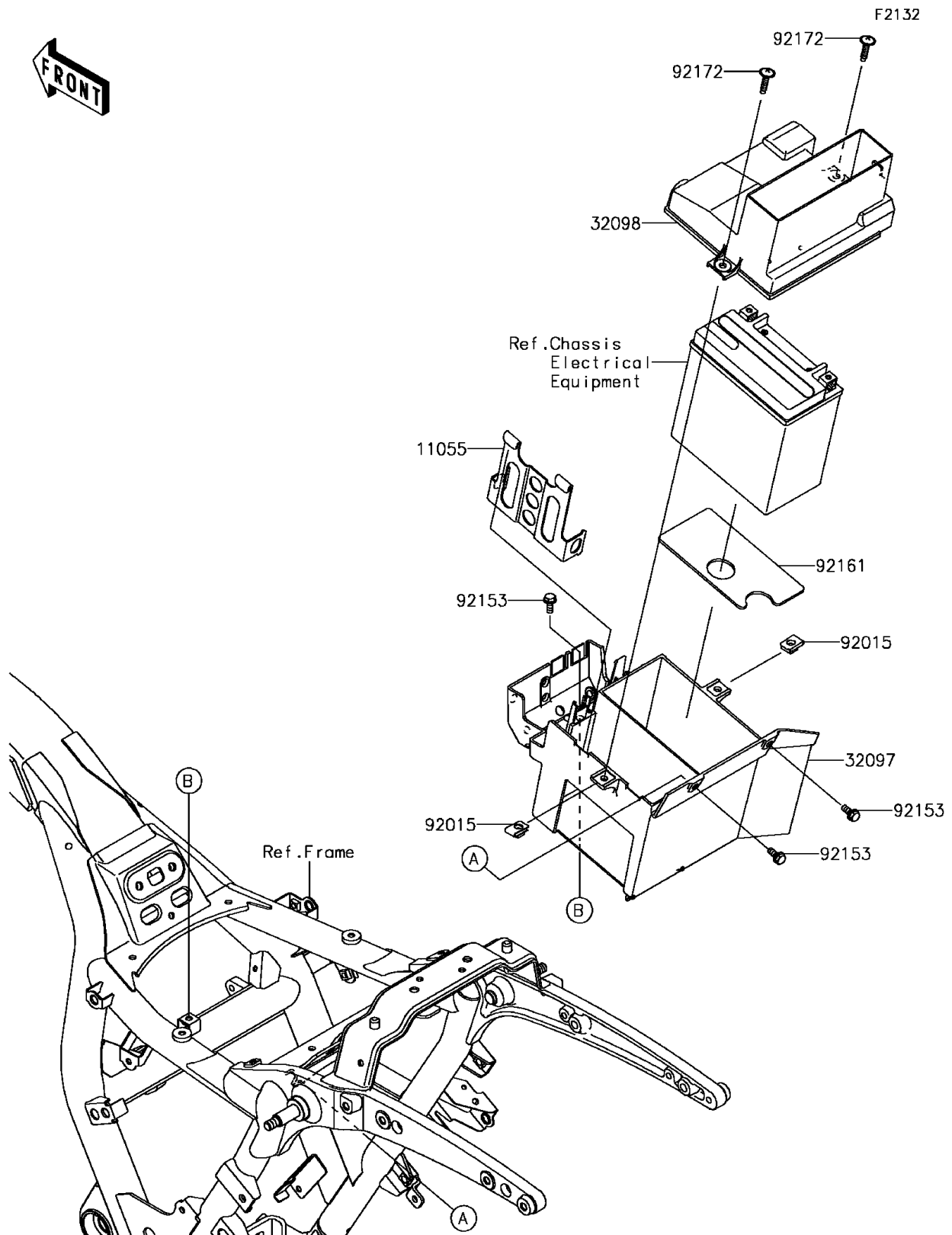

2013 Vulcan® 1700 Voyager® ABS PARTS LIST

Battery Case

ITEM NAME	PART NUMBER	QUANTITY
BRACKET,ECU&RELAY BOX (Ref # 11055)	11055-0617	1
CASE-BATTERY (Ref # 32097)	32097-0027	1
CASE-TOOL (Ref # 32098)	32098-0020	1
NUT,6MM (Ref # 92015)	92015-1602	1
BOLT,6X16 (Ref # 92153)	92153-1215	1
DAMPER,BATTERY (Ref # 92161)	92161-1097	1
SCREW,6X26 (Ref # 92172)	92172-0137	1