

2013 Vulcan® 1700 Voyager® ABS PARTS DIAGRAM

Camshaft(s)/Tensioner

E1230

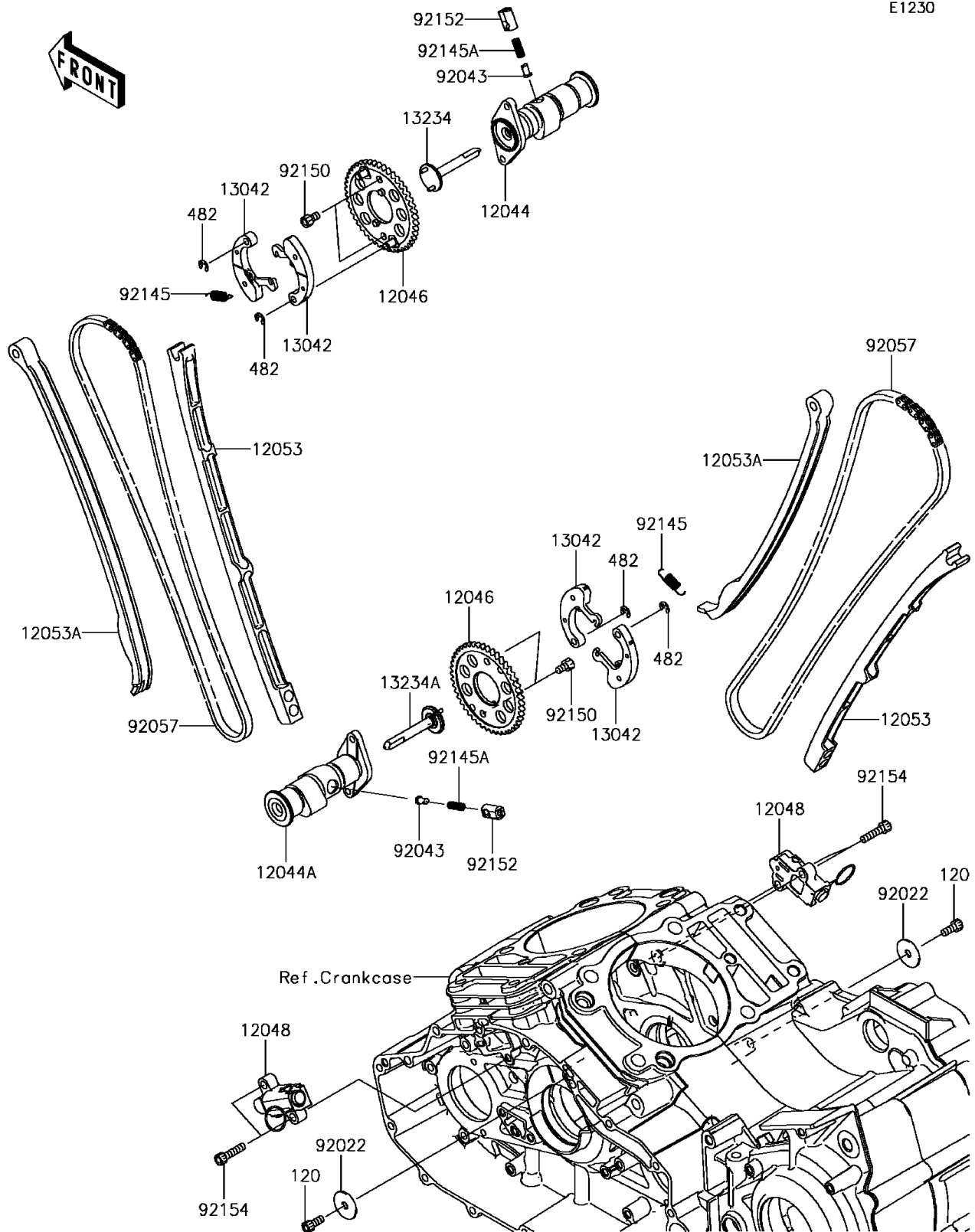

2013 Vulcan® 1700 Voyager® ABS PARTS LIST

Camshaft(s)/Tensioner

ITEM NAME	PART NUMBER	QUANTITY
BOLT-SOCKET,6X14 (Ref # 120)	120CA0614	1
CIRCLIP-TYPE-E,5MM (Ref # 482)	482J5000	1
CAMSHAFT-VALVE,FR (Ref # 12044)	12044-0134	1
CAMSHAFT-VALVE,RR (Ref # 12044A)	12044-0135	1
SPROCKET,CAMSHAFT,46T (Ref # 12046)	12046-0064	1
TENSIONER-ASSY,CAM CHAIN (Ref # 12048)	12048-0053	1
GUIDE-CHAIN,FIXED SIDE (Ref # 12053)	12053-0120	1
GUIDE-CHAIN,TENSIONER SIDE (Ref # 12053A)	12053-0121	1
WEIGHT,DECOMP (Ref # 13042)	13042-0028	1
SHAFT-COMP,FR CAMSHAFT (Ref # 13234)	13234-0040	1
SHAFT-COMP,RR CAMSHAFT (Ref # 13234A)	13234-0041	1
WASHER,7X27X1.6 (Ref # 92022)	92022-227	1
PIN (Ref # 92043)	92043-0163	1
CHAIN,CAM,98XRH2010-146M (Ref # 92057)	92057-0154	1
SPRING,8X0.4X20 (Ref # 92145)	92145-0586	1
SPRING,5.9X0.4X16.5 (Ref # 92145A)	92145-0589	1
BOLT,SOCKET,6X10 (Ref # 92150)	92150-1650	1
COLLAR (Ref # 92152)	92152-0650	1
BOLT,SOCKET,6X25 (Ref # 92154)	92154-0477	1