

1993 KLR250 PARTS DIAGRAM

Engine Cover(s)

E1431

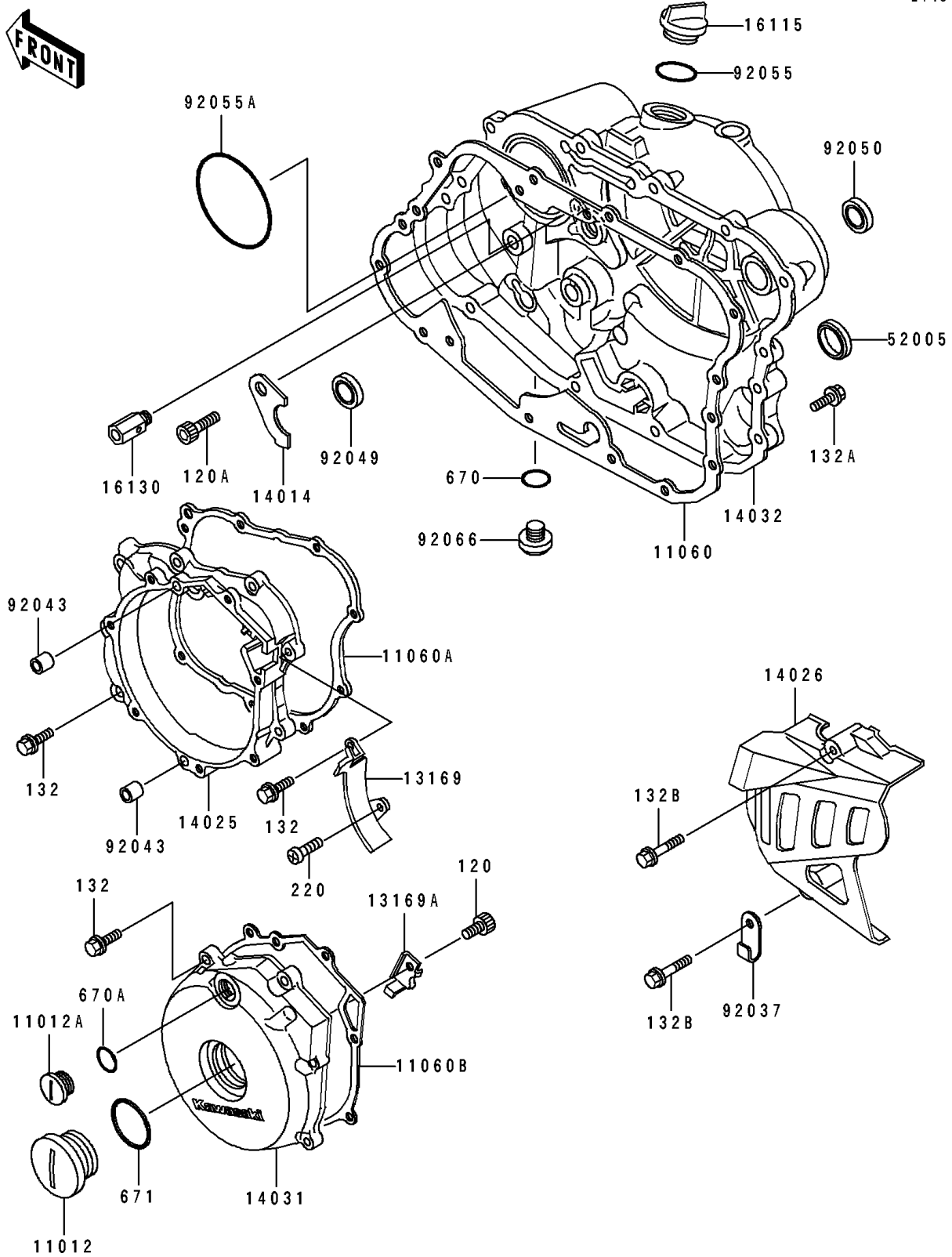

1993 KLR250 PARTS LIST

Engine Cover(s)

ITEM NAME	PART NUMBER	QUANTITY
CAP (Ref # 11012)	11012-1362	1
CAP, TOP MARK (Ref # 11012A)	11012-1363	1
GASKET, CLUTCH COVER (Ref # 11060)	11060-1127	1
GASKET, GENERATOR CASE COVER (Ref # 11060A)	11060-1128	1
GASKET, GENERATOR COVER (Ref # 11060B)	11060-1129	1
PLATE (Ref # 13169)	13169-1879	1
PLATE, GENERATOR LEAD (Ref # 13169A)	13169-1880	1
PLATE-POSITION (Ref # 14014)	14014-1062	1
COVER, GENERATOR CASE (Ref # 14025)	14025-1911	1
COVER-CHAIN (Ref # 14026)	14026-1112	1
COVER-GENERATOR (Ref # 14031)	14031-1238	1
COVER-CLUTCH (Ref # 14032)	14032-1277	1
CAP-OIL FILLER (Ref # 16115)	16115-1009	1
VALVE-ASSY-RELIEF (Ref # 16130)	16130-1001	1
GAUGE, OIL LEVEL (Ref # 52005)	52005-1009	1
CLAMP, WIRING HARNESS (Ref # 92037)	92037-1069	1
PIN, 6.2X8X14 (Ref # 92043)	92043-1263	1
SEAL-OIL (Ref # 92049)	92049-1191	1
SEAL-OIL (Ref # 92050)	92050-078	1
RING-O, 31.5X2.6 (Ref # 92055)	92055-049	1
RING-O, 62.6X66X3.1 (Ref # 92055A)	92055-1221	1
PLUG, DRAIN (Ref # 92066)	92066-1156	1
BOLT-SOCKET (Ref # 120)	120P0608	1
BOLT-SOCKET, 6X10 (Ref # 120A)	120P0610	1
BOLT-FLANGED-SMALL (Ref # 132)	132J0625	1
BOLT-FLANGED-SMALL (Ref # 132A)	132J0630	1
BOLT-FLANGED-SMALL (Ref # 132B)	132J0645	1
SCREW-PAN-CROS, 6X8 (Ref # 220)	220B0608	1
O RING, 11MM (Ref # 670)	670B2011	1

1993 KLR250 PARTS LIST

Engine Cover(s)

ITEM NAME	PART NUMBER	QUANTITY
O RING,18MM (Ref # 670A)	670B2018	1
O RING,40MM (Ref # 671)	671B2540	1