

1997 KE100 PARTS DIAGRAM

Kickstarter Mechanism

E1340

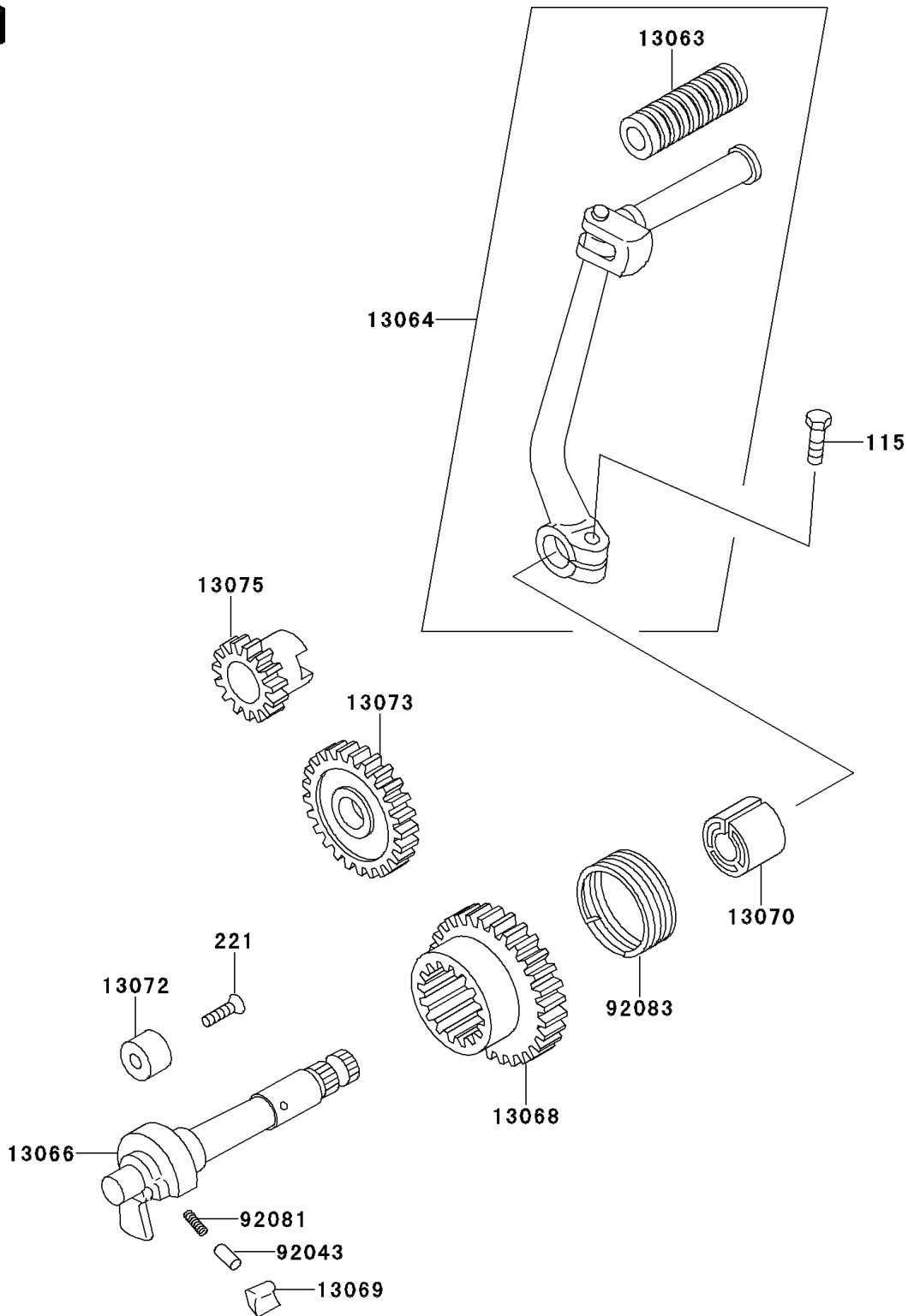

1997 KE100 PARTS LIST

Kickstarter Mechanism

ITEM NAME	PART NUMBER	QUANTITY
BOLT-SMALL-UPSET (Ref # 115)	115J0825	1
SCREW-CSK-CROS,6X20 (Ref # 221)	221B0620	1
DAMPER,PEDAL (Ref # 13063)	13063-002	1
LEVER-ASSY-KICK,PEDAL (Ref # 13064)	13064-1039	1
SHAFT-KICK (Ref # 13066)	13066-1024	1
GEAR-SPUR,KICKSTARTER,35T (Ref # 13068)	13068-007	1
PAWL,KICKSTARTER (Ref # 13069)	13069-005	1
GUIDE,KICK SPRING (Ref # 13070)	13070-1130	1
STOPPER,KICKSTARTER (Ref # 13072)	13072-003	1
GEAR-SPUR,KICKSTARTER.IDLE,30T (Ref # 13073)	13073-004	1
GEAR-SPUR,KICKSTARTER PINION (Ref # 13075)	13075-004	1
PIN,DOWEL,3.9X10.8 (Ref # 92043)	92043-013	1
SPRING,KICK PAWL (Ref # 92081)	92081-014	1
SPRING,KICKSTARTER RETURN (Ref # 92083)	92083-004	1