

2003 JET SKI® 900 STX® PARTS DIAGRAM

Crankcase

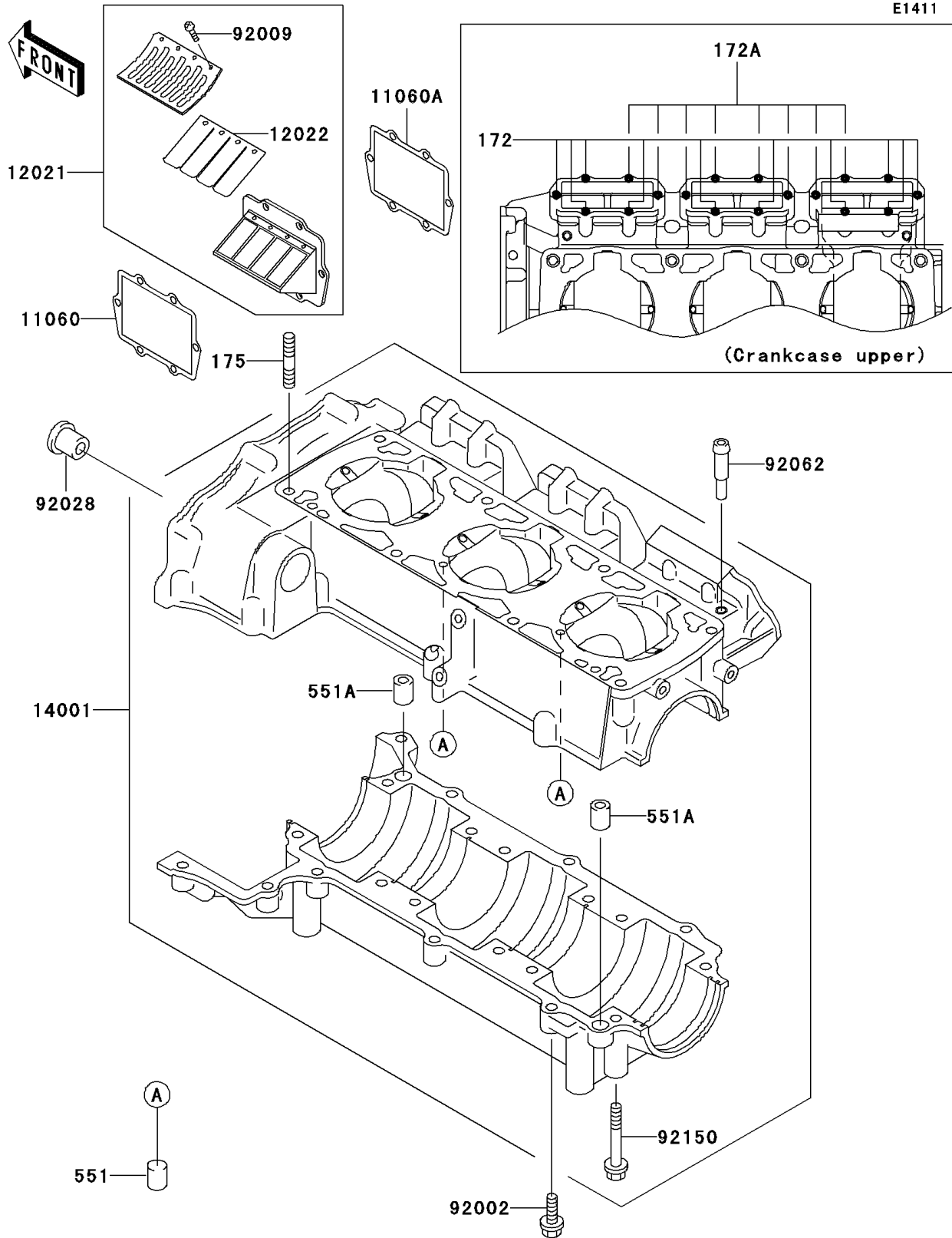

2003 JET SKI® 900 STX® PARTS LIST

Crankcase

| ITEM NAME | PART NUMBER | QUANTITY |
|-----------------------------------|-------------|----------|
| BOLT-STUD (Ref # 172) | 172R0620 | 1 |
| BOLT-STUD (Ref # 172A) | 172R0630 | 1 |
| BOLT-STUD-FINE (Ref # 175) | 175R1035 | 1 |
| PIN-DOWEL (Ref # 551) | 551R0612 | 1 |
| PIN-DOWEL (Ref # 551A) | 551R1012 | 1 |
| GASKET, REED VALVE (Ref # 11060) | 11060-3717 | 1 |
| GASKET, REED VALVE (Ref # 11060A) | 11060-3757 | 1 |
| VALVE-ASSY-REED (Ref # 12021) | 12021-3709 | 1 |
| VALVE-REED (Ref # 12022) | 12022-3703 | 1 |
| SET-CRANKCASE (Ref # 14001) | 14001-5376 | 1 |
| BOLT, 6X30 (Ref # 92002) | 92002-3726 | 1 |
| SCREW, 3X6 (Ref # 92009) | 92009-1371 | 1 |
| BUSHING (Ref # 92028) | 92028-3718 | 1 |
| NOZZLE (Ref # 92062) | 92062-3705 | 1 |
| BOLT, 8X65 (Ref # 92150) | 92150-3708 | 1 |