

2008 Concoors™ 14 PARTS DIAGRAM

Oil Pump/Oil Filter

E1710

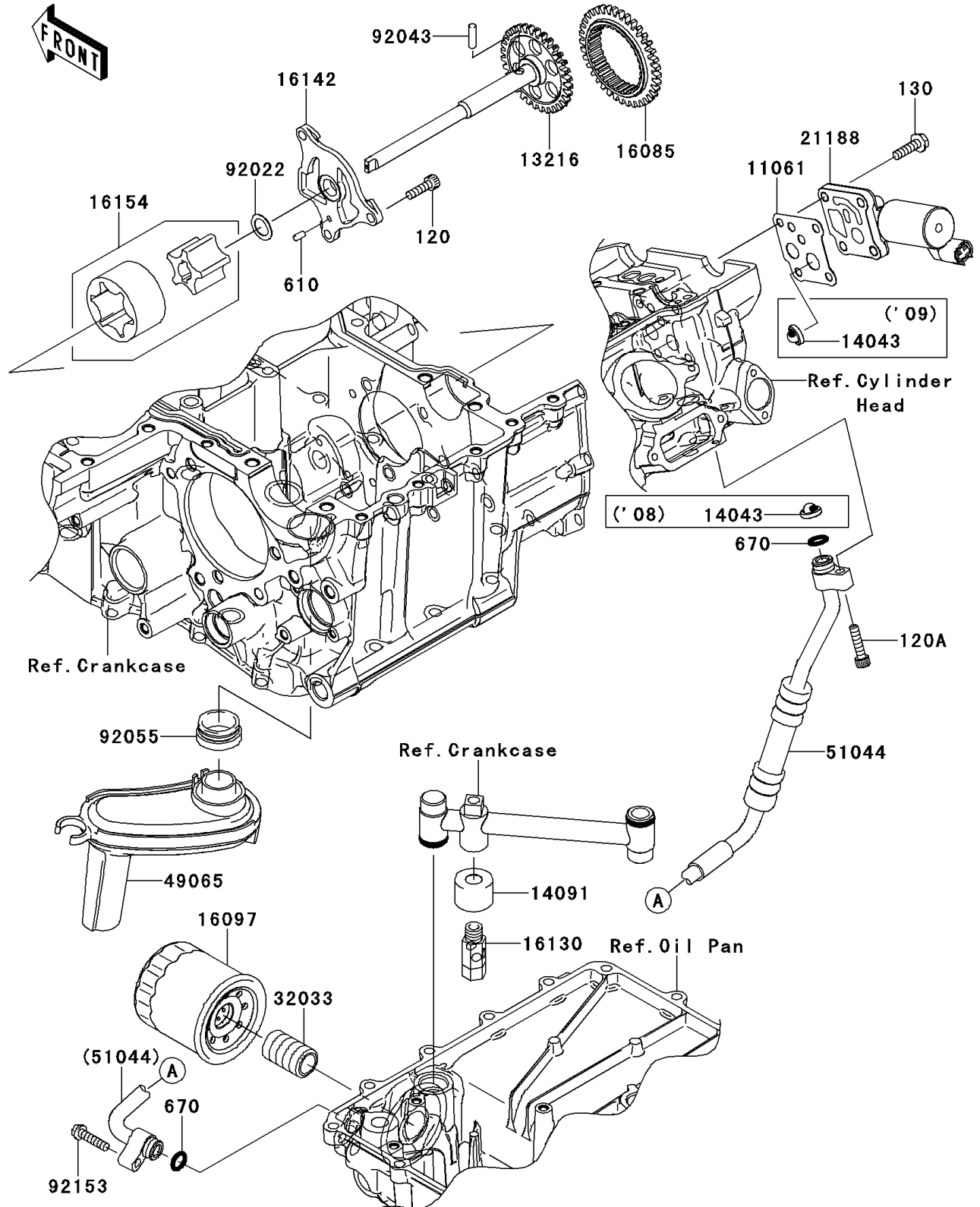

2008 Concours™ 14 PARTS LIST

Oil Pump/Oil Filter

ITEM NAME	PART NUMBER	QUANTITY
BOLT-SOCKET,6X20 (Ref # 120)	120CA0620	1
BOLT-SOCKET,6X25 (Ref # 120A)	120CA0625	1
BOLT-FLANGED,6X22 (Ref # 130)	130BA0622	1
ROLLER,4X8 (Ref # 610)	610A0408	1
O RING,10.8X2.4 (Ref # 670)	670D2011	1
GASKET,SOLENOID (Ref # 11061)	11061-3748	1
GEAR-COMP,OIL PUMP (Ref # 13216)	13216-0024	1
FILTER,ELEMENT (Ref # 14043)	14043-0009	1
COVER,VALVE (Ref # 14091)	14091-0497	1
GEAR (Ref # 16085)	16085-0103	1
FILTER-ASSY-OIL (Ref # 16097)	16097-0004	1
VALVE-ASSY-RELIEF (Ref # 16130)	16130-1059	1
COVER-PUMP (Ref # 16142)	16142-0027	1
ROTOR-PUMP (Ref # 16154)	16154-0047	1
SOLENOID,VVT (Ref # 21188)	21188-0006	1
PIPE,OIL FILTER (Ref # 32033)	32033-1535	1
FILTER-OIL (Ref # 49065)	49065-0014	1
TUBE-ASSY,EG OIL (Ref # 51044)	51044-0049	1
WASHER,13.2X20X0.5 (Ref # 92022)	92022-1224	1
PIN,17.9X5.0 (Ref # 92043)	92043-1444	1
RING-O,OIL FILTER (Ref # 92055)	92055-1503	1
BOLT,FLANGED,6X25 (Ref # 92153)	92153-1795	1