

2006 Bayou® 250 PARTS DIAGRAM

Frame

F2120

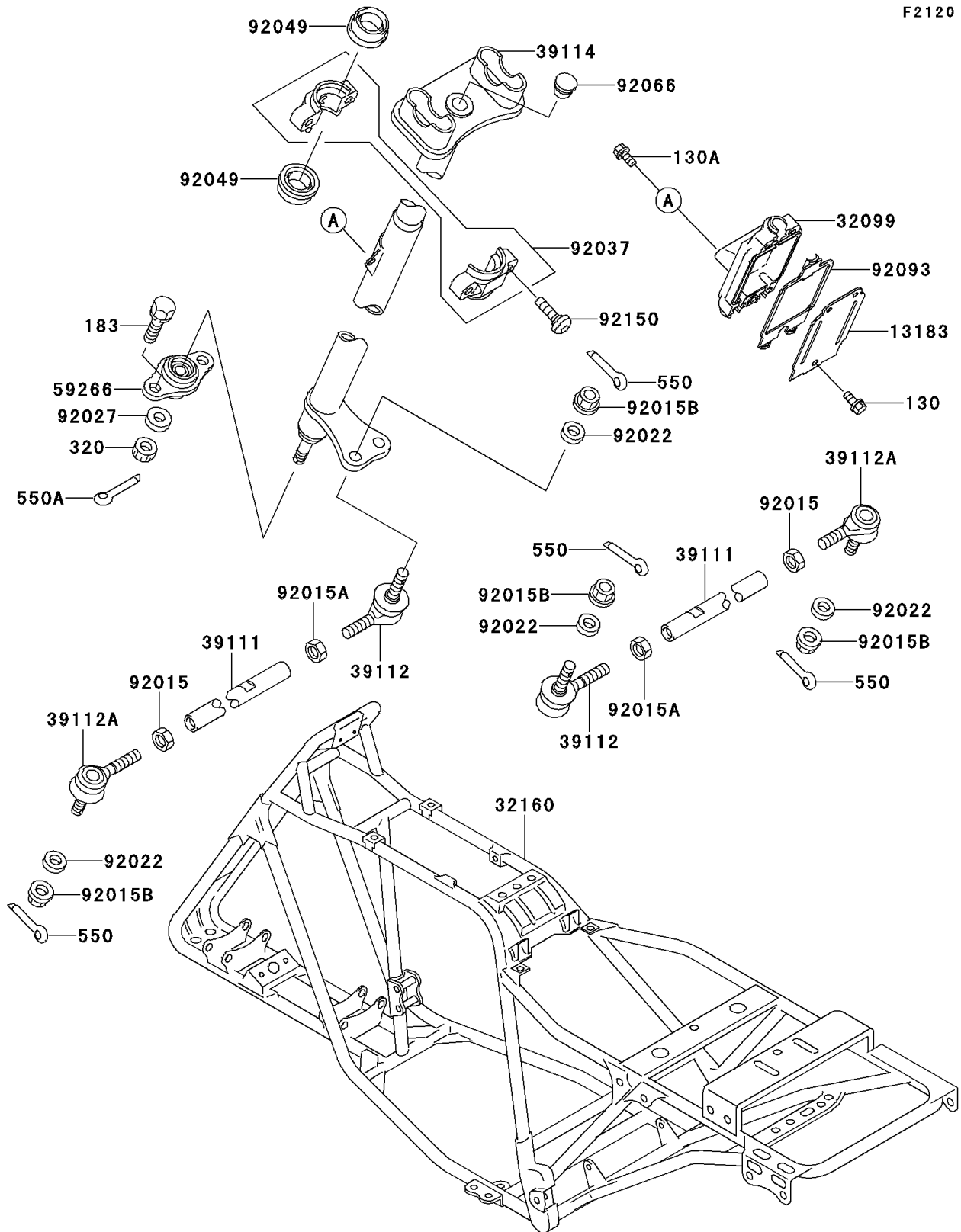

2006 Bayou® 250 PARTS LIST

Frame

ITEM NAME	PART NUMBER	QUANTITY
BOLT-FLANGED,5X12 (Ref # 130)	130BA0512	1
BOLT-FLANGED,6X12 (Ref # 130A)	130BA0612	1
BOLT-UPSET-WS-SMALL,8X22 (Ref # 183)	183BA0822	1
NUT-CASTLE (Ref # 320)	320BA1000	1
PIN-COTTER,2.0X15 (Ref # 550)	550AA2015	1
PIN-COTTER,2.5X18 (Ref # 550A)	550AA2518	1
PLATE,EQUALIZER CASE (Ref # 13183)	13183-1148	1
CASE,EQUALIZER (Ref # 32099)	32099-1101	1
FRAME-COMP (Ref # 32160)	32160-1798	1
ROD-TIE (Ref # 39111)	39111-1076	1
RODEND-TIE (Ref # 39112)	39112-1063	1
RODEND-TIE (Ref # 39112A)	39112-1064	1
SHAFT-COMP-STRG (Ref # 39114)	39114-1065	1
JOINT-BALL (Ref # 59266)	59266-1066	1
NUT,LOCK,10MM (Ref # 92015)	92015-1460	1
NUT,LOCK,10MM (Ref # 92015A)	92015-1494	1
NUT,LOCK,FLANGED,10MM (Ref # 92015B)	92015-1717	1
WASHER,10.5X20X1 (Ref # 92022)	92022-239	1
COLLAR,10X21.3X7 (Ref # 92027)	92027-1817	1
CLAMP,STEERING SHAFT (Ref # 92037)	92037-1975	1
SEAL-OIL,SR7 25 34 7.8 NS (Ref # 92049)	92049-1278	1
PLUG (Ref # 92066)	92066-1220	1
SEAL,EQUALIZER CASE (Ref # 92093)	92093-1246	1
BOLT (Ref # 92150)	92150-1058	1