

2012 ER-6n PARTS DIAGRAM

Starter Motor

E1840

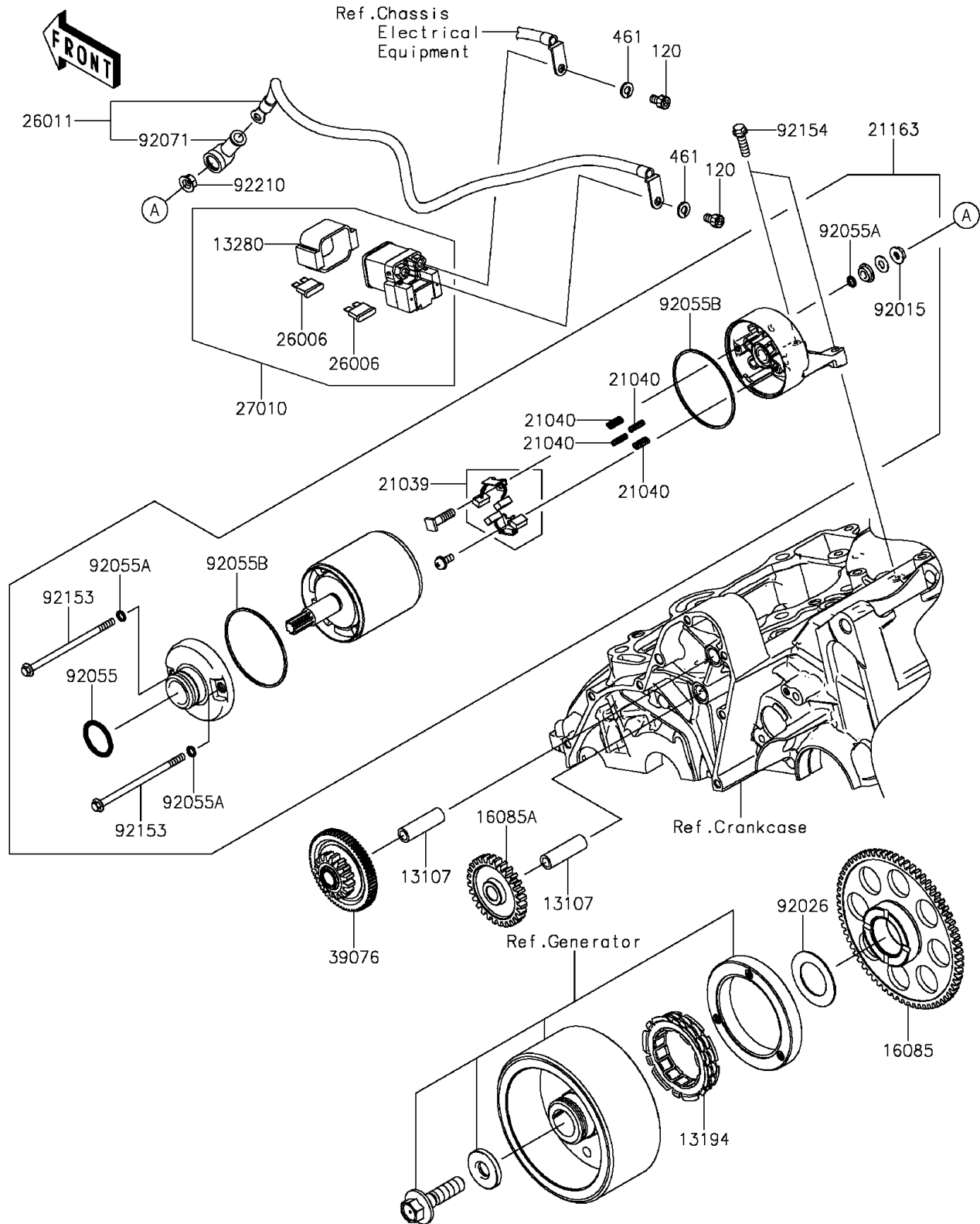

2012 ER-6n PARTS LIST

Starter Motor

ITEM NAME	PART NUMBER	QUANTITY
BOLT-SOCKET,6X10 (Ref # 120)	120CB0610	1
WASHER-SPRING,6MM (Ref # 461)	461DB0600	1
SHAFT,IDLE GEAR (Ref # 13107)	13107-1106	1
CLUTCH-ONEWAY (Ref # 13194)	13194-0015	1
HOLDER (Ref # 13280)	13280-0710	1
GEAR,67T (Ref # 16085)	16085-0076	1
GEAR,IDLE,28T (Ref # 16085A)	16085-0148	1
BRUSH,CARBON (Ref # 21039)	21039-0004	1
SPRING-BRUSH (Ref # 21040)	21040-0003	1
STARTER-ELECTRIC (Ref # 21163)	21163-0040	1
FUSE,BLADE,30A,GREEN (Ref # 26006)	26006-1006	1
WIRE-LEAD (Ref # 26011)	26011-0761	1
SWITCH,MAGNETIC (Ref # 27010)	27010-0709	1
LIMITER,16T&66T (Ref # 39076)	39076-0023	1
NUT,STARTER MOTOR (Ref # 92015)	92015-1476	1
SPACER,29.1X47.5X1.2 (Ref # 92026)	92026-087	1
RING-O (Ref # 92055)	92055-1276	1
RING-O,4.5X2.0 (Ref # 92055A)	92055-1370	1
RING-O,STARTER MOTOR (Ref # 92055B)	92055-1381	1
GROMMET (Ref # 92071)	92071-0024	1
BOLT (Ref # 92153)	92153-1783	1
BOLT,FLANGED,6X22 (Ref # 92154)	92154-0504	1
NUT,6MM (Ref # 92210)	92210-0188	1