

2015 NINJA® 300 ABS PARTS DIAGRAM

Cables

F2540

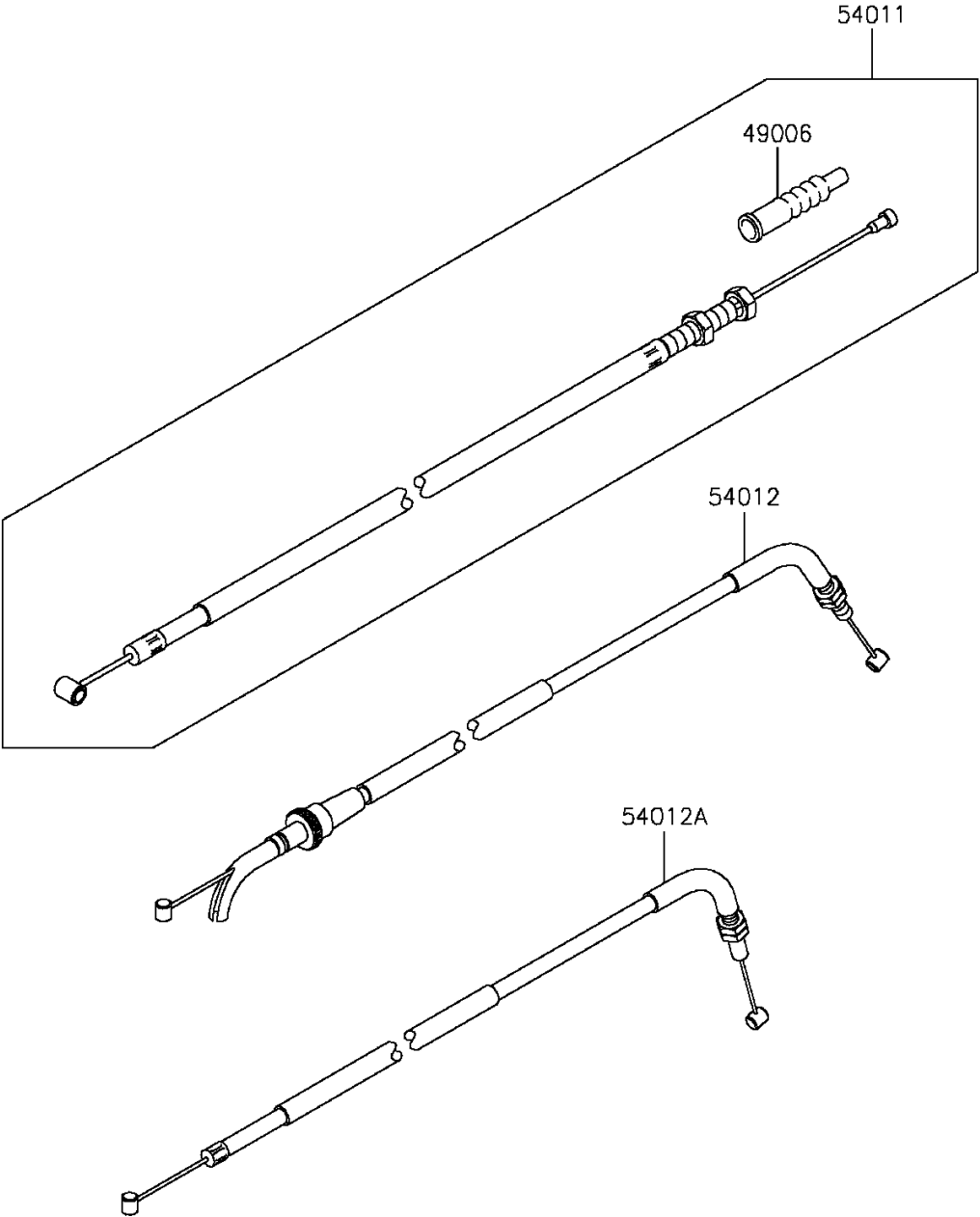

2015 NINJA® 300 ABS PARTS LIST

Cables

ITEM NAME	PART NUMBER	QUANTITY
BOOT,CLUTCH CABLE (Ref # 49006)	49006-0579	1
CABLE-CLUTCH (Ref # 54011)	54011-0565	1
CABLE-THROTTLE,PULL (Ref # 54012)	54012-0577	1
CABLE-THROTTLE,RETURN (Ref # 54012A)	54012-0578	1