

2015 NINJA® 300 ABS PARTS DIAGRAM

Crankshaft

E1321

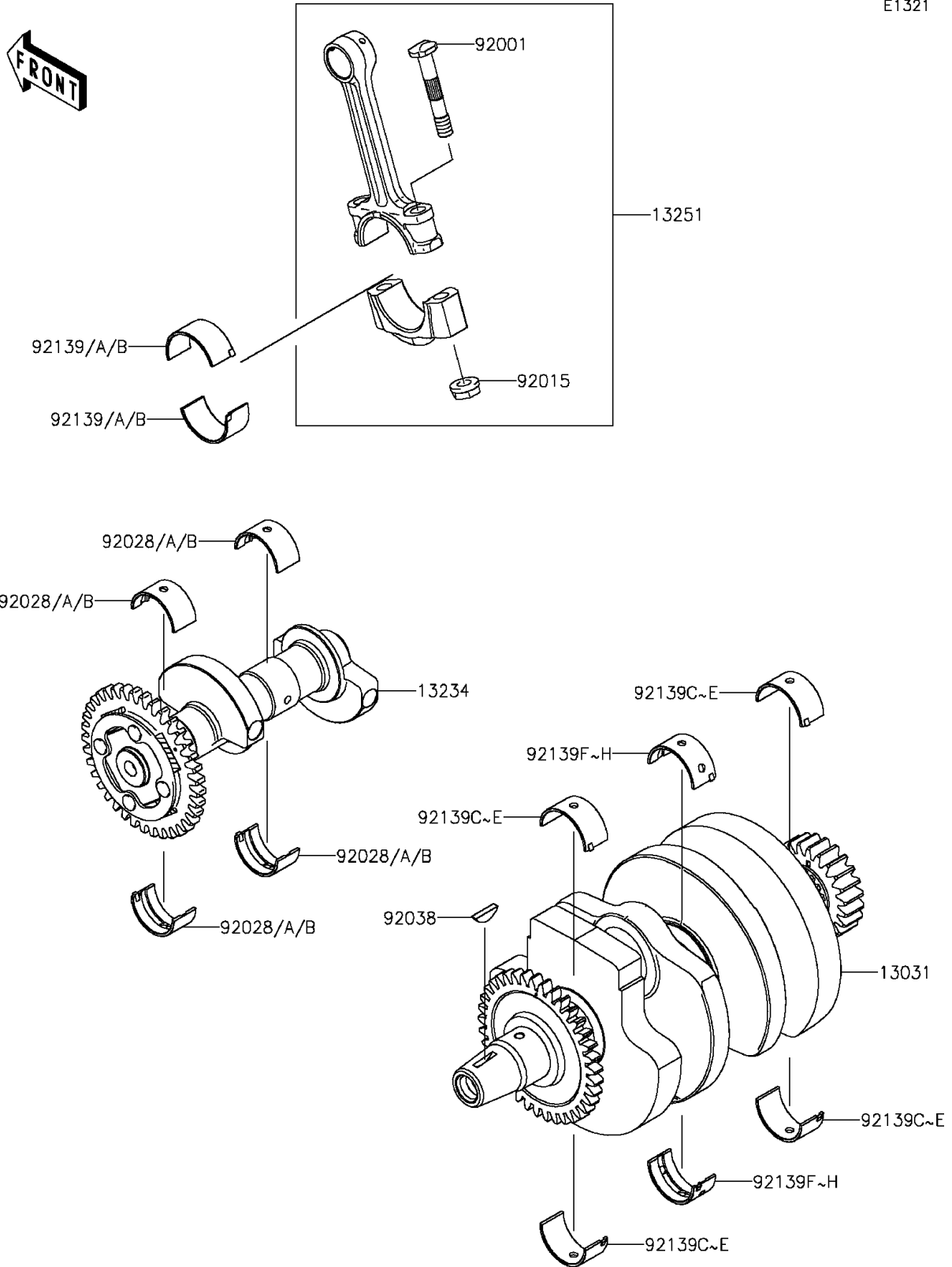

2015 NINJA® 300 ABS PARTS LIST

Crankshaft

ITEM NAME	PART NUMBER	QUANTITY
CRANKSHAFT-COMP,B MK,RED (Ref # 13031)	13031-0770	1
SHAFT-COMP,BALANCER (Ref # 13234)	13234-0591	1
ROD-ASSY-CONNECTING,I (Ref # 13251)	13251-0037-II	1
BOLT,CONNECTING ROD,7MM (Ref # 92001)	92001-1793	1
NUT,CONNECTING ROD,7MM (Ref # 92015)	92015-1527	1
BUSHING,BALANCER,BLUE (Ref # 92028)	92028-1422	1
BUSHING,BALANCER,BLACK (Ref # 92028A)	92028-1423	1
BUSHING,BALANCER,BROWN (Ref # 92028B)	92028-1424	1
KEY,WOODRUFF (Ref # 92038)	92038-001	1
BUSHING,CONNECTING ROD,BLUE (Ref # 92139)	92139-0782	1
BUSHING,CONNECTING ROD,BLACK (Ref # 92139A)	92139-0783	1
BUSHING,CONNECTING ROD,BROWN (Ref # 92139B)	92139-0784	1
BUSHING,CRANK #1,BLUE (Ref # 92139C)	92139-0786	1
BUSHING,CRANK #1,BLACK (Ref # 92139D)	92139-0787	1
BUSHING,CRANK #1,YELLOW (Ref # 92139E)	92139-0788	1
BUSHING,CRANK #2,BLUE (Ref # 92139F)	92139-0790	1
BUSHING,CRANK #2,BLACK (Ref # 92139G)	92139-0791	1
BUSHING,CRANK #2,YELLOW (Ref # 92139H)	92139-0792	1